

## **ELEMENTAL SERIES WATER BATH**

### **OPERATING MANUAL**

#### **NON CIRCULATING WATER BATH**

**WLC005**  
**WLC012**  
**WLC020**

#### **CIRCULATING WATER BATH**

**WLS005**  
**WLS012**  
**WLS020**

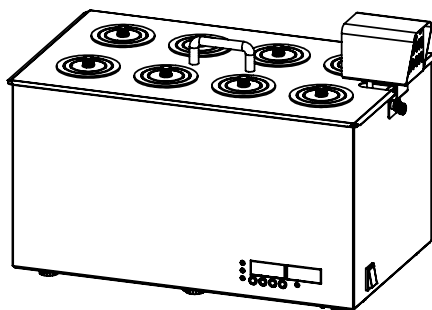
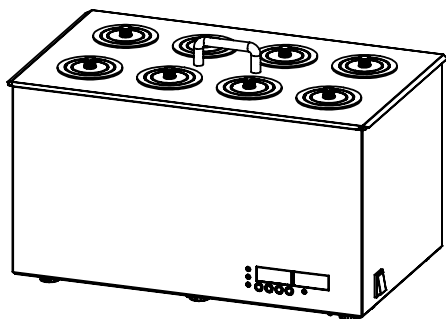

**DEALER :**



## THANK YOU NOTE

*We Borosil, one of India's most customer oriented brands truly appreciate your business and express our gratitude for the trust you have placed on us.*

*We hope your choice serves you well in your scientific endeavors and aspire to have the pleasure of doing business with you for years to come.*



## TABLE OF CONTENTS

<b>Sr. No.</b>	<b>Particular</b>	<b>Page No.</b>
1.	Packing List	7
2.	Product Specification of WLS020/ WLC020	8
3.	Product Specification of WLS012/ WLC012	9
4.	Product Specification of WLS005/ WLC005	10
5.	Safety and Warning	11
6.	Safety Instructions	12
7.	Unboxing of Non Circulating Elemental Series Waterbath	13
8.	Unboxing of Circulating Elemental Series Waterbath	14
9.	Product Identification of Non Circulating Elemental Series Waterbath	15
10.	Product Identification of Circulating Elemental Series Waterbath	16
11.	Setting Up	17
12.	Getting Started	18
13.	General Operating Instructions	19
14.	Description of Buttons & Functions	20
15.	Features of WLC & WLS Series	21
16.	Operation of WLC & WLS Series	31
17.	Pop-up Errors in WLC & WLS Series	34
18.	Troubleshooting	35
19.	Warranty Registration	37
20.	Statement of Warranty	39
21.	Contact Information	40



## **PACKING LIST**

1. Perforated tray.....01 No.
2. Leveling shoes
  - a) WLC020 / WLS020.....06 Nos.
  - b) WLC012 / WBS012.....04 Nos.
  - c) WLC005 / WLS005.....04 Nos.
3. Operating Manual.....01 No.
4. Fuse
  - a) WLC020 / WLS020 - 8 Amps.....02 Nos.
  - b) WLC012 / WBS012 - 5 Amps.....02 Nos.
  - c) WLC005 / WLS005 - 2 Amps.....02 Nos.
5. Power Cable.....01 No.
6. WLS Overhead stirrer
  - a) WLS005 / WLS012 / WLS020.....01 No.

## PRODUCT SPECIFICATION OF WLS020 / WLC020

<b>PARAMETERS</b>	<b>WLS020</b>	<b>WLC020</b>
Internal dimensions (WxDxH)	500mm x 300mm x 150mm	500mm x 300mm x 150mm
Unit External Dimensions (WxDxH)	590mm x 340mm x 415mm	540mm x 340mm x 300mm
Mains voltage	220v - 240v	220v - 240v
Current consumption	7A	7A
Power consumptions	1600w	1600w
Temperature range	Ambient to 99°C	Ambient to 99°C
Tank material	SS 304	SS 304
Display	7 Segment LED	7 Segment LED
Inbuilt temperature probe	PT-100	PT-100
Accuracy in temp.	(+/-) 0.5 Degree	(+/-) 0.5 Degree
Timer Display	Yes (Max 99hr:59min)	Yes (Max 99hr:59min)
RPM	1500	No
Safety temp limit cut off	Yes (99 degree)	Yes (99 degree)
Water drain valve	Yes	Yes
Media stirrer	Yes	No
Error setting	Yes	Yes
1 point calibration	Yes	Yes
2 point calibration	Yes ( 37°C & 70°C)	Yes ( 37°C & 70°C)
PID settings	Yes	Yes
Probe error detection	Yes ( If any open circuit)	Yes ( If any open circuit)

## PRODUCT SPECIFICATION OF WLS012 / WLC012

<b>PARAMETERS</b>	<b>WLS012</b>	<b>WLC012</b>
Internal dimensions (WxDxH)	330mm x 300mm x 150mm	330mm x 300mm x 150mm
Unit External Dimensions (WxDxH)	395mm x 340mm x 415mm	375mm x 340mm x 300mm
Mains voltage	220v - 240v	220v - 240v
Current consumption	4A	4A
Power consumptions	900w	900w
Temperature range	Ambient to 99°C	Ambient to 99°C
Tank material	SS 304	SS 304
Display	7 Segment LED	7 Segment LED
Inbuilt temperature probe	PT-100	PT-100
Accuracy in temp.	(+/-) 0.5 Degree	(+/-) 0.5 Degree
Timer Display	Yes (Max 99hr:59min)	Yes (Max 99hr:59min)
RPM	1500	No
Safety temp limit cut off	Yes (99 degree)	Yes (99 degree)
Water drain valve	Yes	Yes
Media stirrer	Yes	No
Error setting	Yes	Yes
1 point calibration	Yes	Yes
2 point calibration	Yes ( 37°C & 70°C)	Yes ( 37°C & 70°C)
PID settings	Yes	Yes
Probe error detection	Yes ( If any open circuit)	Yes ( If any open circuit)

## PRODUCT SPECIFICATION OF WLS005 / WLC005

<b>PARAMETERS</b>	<b>WLS005</b>	<b>WLC005</b>
Internal dimensions (WxDxH)	325mm x 175mm x 150mm	300mm x 150mm x 150mm
Unit External Dimensions (WxDxH)	365mm x 180mm x 415mm	330mm x 180mm x 300mm
Mains voltage	220v - 240v	220v - 240v
Current consumption	2A	2A
Power consumptions	400w	400w
Temperature range	Ambient to 99°C	Ambient to 99°C
Tank material	SS 304	SS 304
Display	7 Segment LED	7 Segment LED
Inbuilt temperature probe	PT-100	PT-100
Accuracy in temp.	(+/-) 0.5 Degree	(+/-) 0.5 Degree
Timer Display	Yes (Max 99hr:59min)	Yes (Max 99hr:59min)
RPM	1500	No
Safety temp limit cut off	Yes (99 degree)	Yes (99 degree)
Water drain valve	No	No
Media stirrer	Yes	No
Error setting	Yes	Yes
1 point calibration	Yes	Yes
2 point calibration	Yes ( 37°C & 70°C)	Yes ( 37°C & 70°C)
PID settings	Yes	Yes
Probe error detection	Yes ( If any open circuit)	Yes ( If any open circuit)

## SAFETY AND WARNING



Important operating and maintenance instructions.

Read the accompanying text carefully.



### Potential Electrical Hazards

- Only qualified persons should perform procedures associated with this equipment.
- Equipment must be turned off and disconnected during maintenance/service.
- Equipment to be connected to power with proper earthing. The manufacturer is not liable for any injury or death resulting from electrical hazards due to faulty supply to the equipment.



Ensure to remove the power plug post power failure.

## SAFETY INSTRUCTIONS

- On long hours of usage the equipment surface may be heated.
- Do not operate the equipment unattended / unsupervised.
- This is a heating equipment hot surfaces may cause burns & materials which may be affected by elevated temperatures.
- The Ceramic wool insulation emits fumes in the first few hours of operation. Ensure proper ventilation during first use.
- Always use proper protective equipments. (Clothing, gloves, goggles, etc.)
- Always follow good hygiene practices.
- Each individual is responsible for his / her own safety.
- Drain the water from the tube only after it reaches to ambient.

- Please note that lowest set value for temperature is ambient +5°C and highest set value is 99°C.
- Do not run the unit without water. Use always distilled water or RO water to avoid scaling.
- Never use cracked or leaking containers inside the bath.
- In case of chemical spillage inside the pan, clean immediately. Drain and clean the bath regularly to prevent organic growth.
- Wipe clean and maintain the bath dry when not in use. Sanitise wipes are recommended.
- Do not keep unit on wet bench top.
- The unit should be plugged to standard 230V, 3 pin, power socket having proper earthing.
- If the water spills on the control box, first switch off the unit and wipe dry. Restart only after unit is dry.
- Do not check the water temperature with your body.



Open the lid during the operation with caution as instant steam release can cause severe burns.

## UNBOXING OF ELEMENTAL SERIES WATERBATH

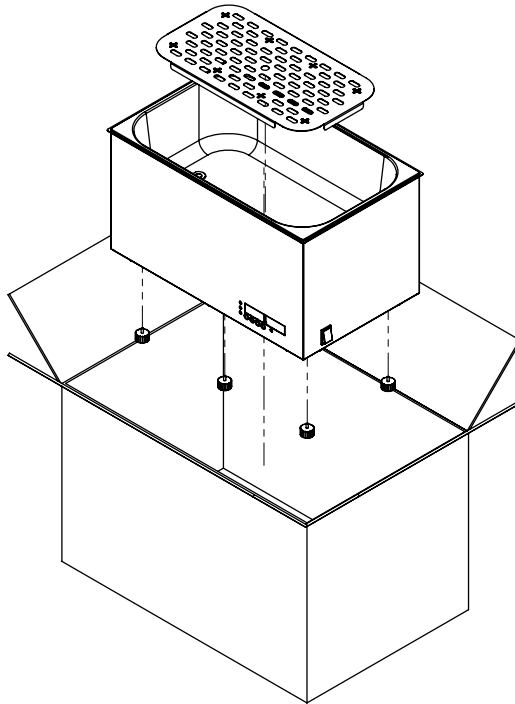

### UNBOXING INSTRUCTION:

1. Remove rubber shoes, perforated tray, power cable and agitator.
2. Remove the Water Bath unit safely.
3. Any damage at receipt should be reported to the dealer / delivery agent.

**(Read manual before installation on the lab bench.)**

## UNBOXING OF CIRCULATING ELEMENTAL WATERBATH

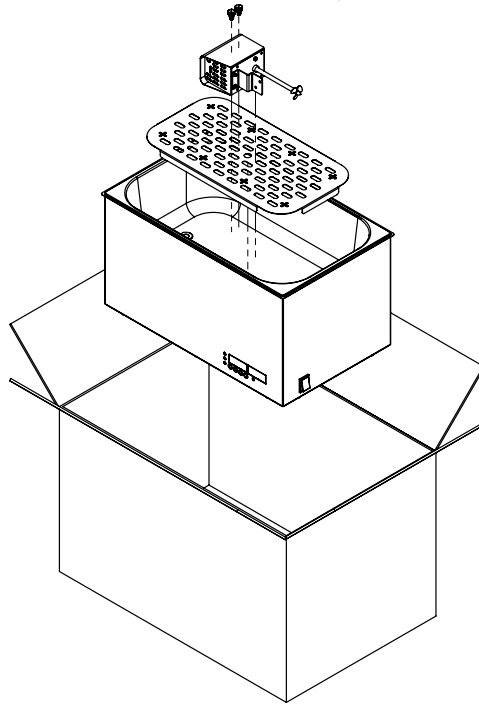

### UNBOXING INSTRUCTION:

1. Remove rubber shoes, perforated tray, power cable and agitator.
2. Remove the Water Bath unit safely.
3. Any damage at receipt should be reported to the dealer / delivery agent.

**(Read manual before installation on the lab bench.)**

## PRODUCT IDENTIFICATION OF ELEMENTAL WATER BATH

- A. PERFORATED TRAY
- B. CONTROL PANEL
- C. ON/OFF
- D. POWER SOCKET
- E. COOLING FAN
- F. DRAIN VALVE
- G. DRAIN PIPE CONNECTOR
- H. RUBBER SHOES

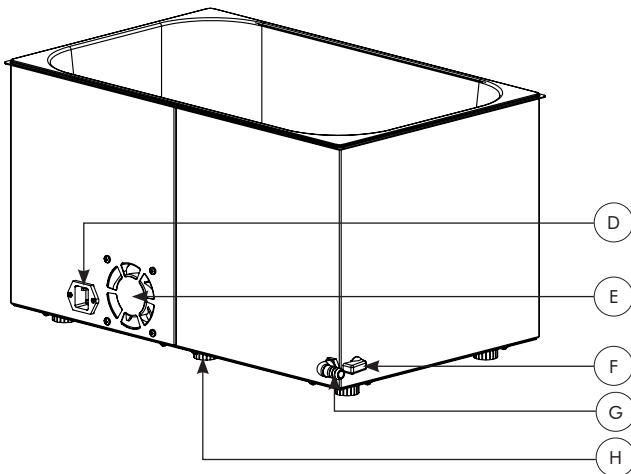
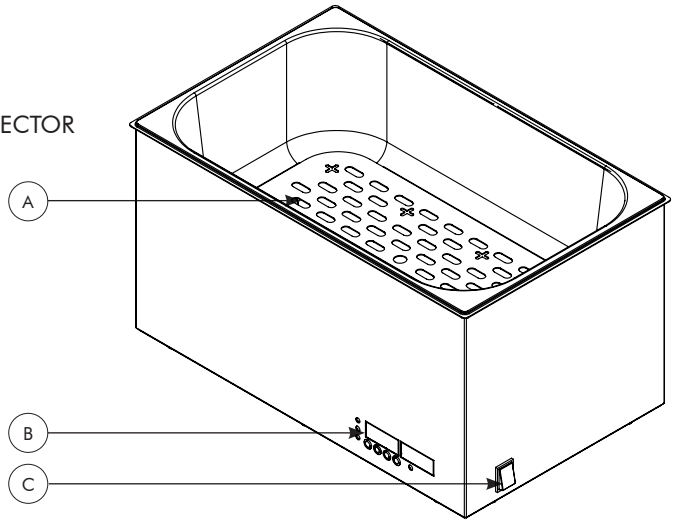

## PRODUCT IDENTIFICATION OF CIRCULATING ELEMENTAL WATER BATH

- A. PERFORATED TRAY
- B. AGITATOR
- C. CONTROL PANEL
- D. ON/OFF
- E. AGITATOR CONNECTOR
- F. POWER SOCKET
- G. COOLING FAN
- H. DRAIN VALVE
- I. DRAIN PIPE CONNECTOR
- J. RUBBER SHOES

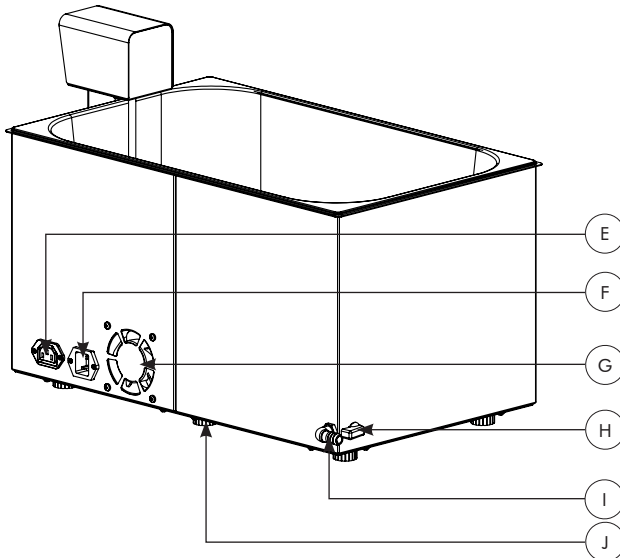
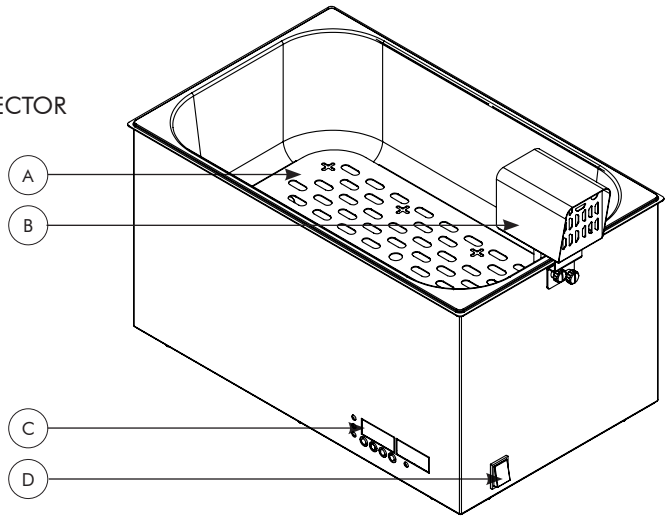

**WATER BATH**

## SETTING UP

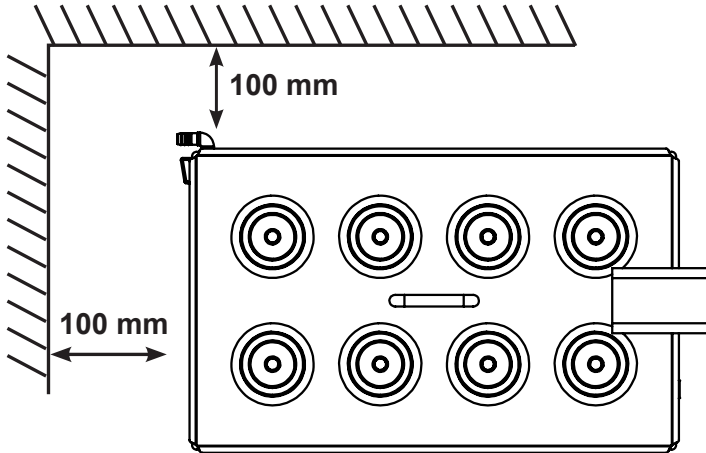

Figure: 17.1

1. Insert the leveling shoes at the base and tighten it.
2. Make sure that minimum 100mm gap is maintained between body and wall as shown in fig. 17.1.
3. Ensure that the power switch is in "OFF" position.
4. Please ensure there is a fuse in the fuse holder.
5. Connect the male end of power cable to the wall socket.
6. The unit is ready to operate for first usage.

## FIRST TIME OPERATION

1. Connect the power supply to a properly earthed power socket.
2. Fill the water till the filling step in the tank.
3. Switch ON the wall power socket.
4. Switch ON the red illuminated switch which is given on the back side of the unit.
5. Set the temperature to 90°C. (SETTING THE TEMP. EXPLAINED IN OPERATION OF THE WLS/WLC SERIES).



### CAUTION !

6. Once the process started, user can see the temperature rising in the display.
7. Please ensure adequate ventilation is proper during first operation for protection from fumes emitted by Ceramic insulation.
8. Check whether the current is flowing in the body by using a tester, do not touch the unit by bare hands.



### WARNING !

9. If the tester lights, switch off the unit and remove the power cable from the wall and check earthing. If the problem persists, do not operate the unit and please contact Borosil Service Center.
10. Once the fumes are reduced (normally past 5 minutes to 10 minutes of operation), set temperature to approx ambient temp. and switch OFF.
11. Allow the unit cool to ambient temperature.
12. Now the unit is ready for regular usages.

## GENERAL OPERATING INSTRUCTIONS

1. Place the perforated tray inside the tub.
2. Pour the distilled water till the filling step of the tank.
3. Place the flasks on the perforated tray (Follow the guiding marks on the perforated tray).
4. Place the cap on the unit with ring set, in the position.
5. In case of operations, please make sure that the weight is balanced after connecting the apparatus in retort stand.
6. Switch ON power.
7. Set the desired temperature by using controller ( Min 25°, Max 99°).
8. Do not pour or spill the liquid on the control box. If any water drop falls, wipe dry.
9. It is recommended to set the ambient temp. before switching it off.
10. After operation it is recommended, drain the water from the tub.

## DESCRIPTION OF BUTTONS & FUNCTIONS

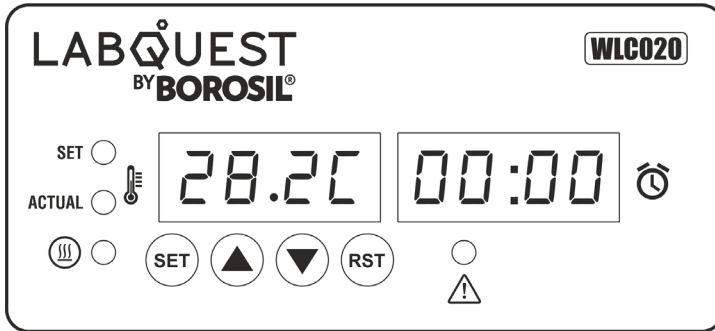

### 1. SET :

- **Single press** selects the parameter which needs to be set and also to start the process.
- **Long press** is used to enter in to the setting menu.

### 2. UP (▲) :

- To increase the set point values and to scroll up the setting menu.

### 3. DOWN (▼) :

- To decrease the set point values and to scroll down the setting menu.

### 4. RESET (RST) :

- **Single press** used to go back to previous state (back function) and to exit from settings mode.
- **Long press** used to exit from the settings menu and to stop the process.

## FEATURES OF WLS & WLC SERIES

- Long press SET button to enter SETTINGS menu while current temperature is displayed on first display and time is 00:00 on second display.
- In settings, Left side display will show Parameter while right side display shows selected previous stored values.
- To change value of Parameter single press SET button then second display will start blinking. To change current values press ▲ or ▼ button.
- For save that change values, single press SET button. Second display will stop blinking and user will see the selected values of parameter on second display.
- If user don't want to change the values of parameter and want the previous selected values of parameter then single press RST button and parameter will stop blinking and user will see the previous selected parameter's values on second display.

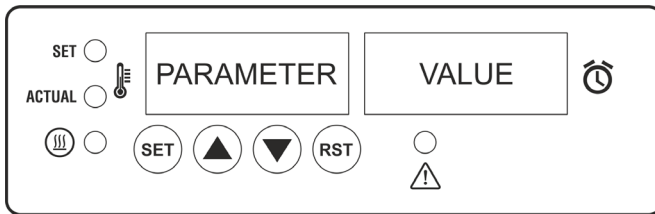

### 1. Stirrer

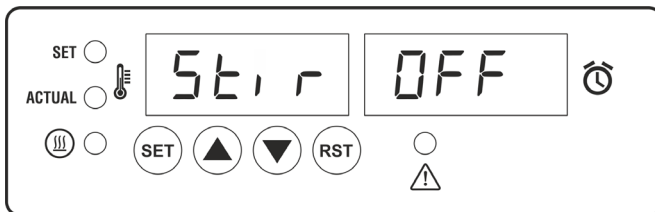
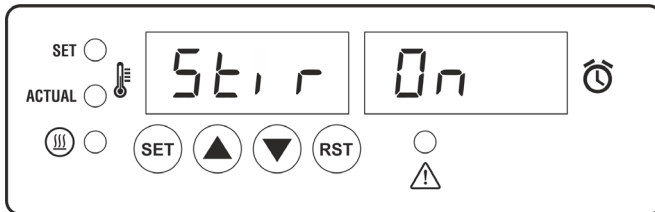

- This feature is available only for WLS series and not for WLC series.
- This feature is used to on and off stirrer.

## 2. Unit

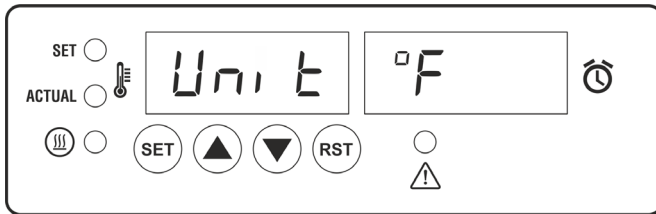
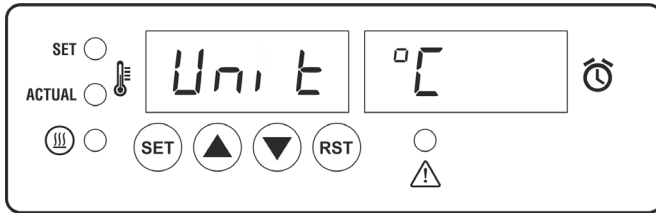

- User can select temperature's unit in °C (degree celsius) or °F (degree fahrenheit).

## 3. Safe

- In this feature, user can lock the maximum set temperature.
- If selected unit is °C then user can select between ambient to maximum value of 99°C.

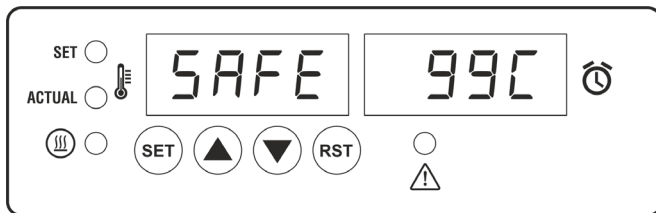

- Example : If the user locks internal set temperature value to 55°C using the safe function and saves it, then user can only set probe temperature value upto on 55°C.

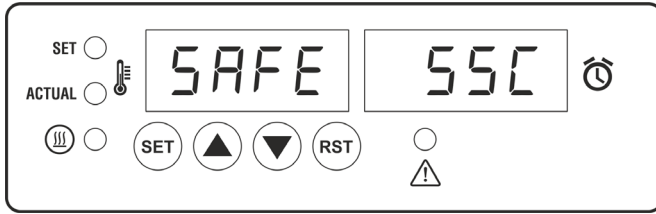

- If selected unit is °F then user can select between ambient to maximum value of 212°F.

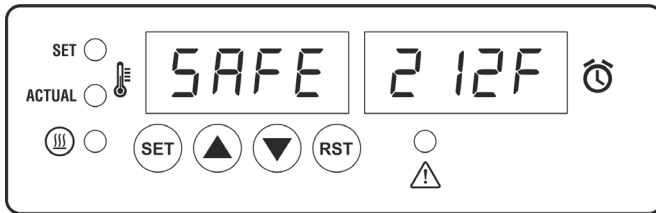

- Example : If the user locks internal set temperature value to 125°F using the safe function and saves it, then user can only set probe temperature value upto on 125°F.

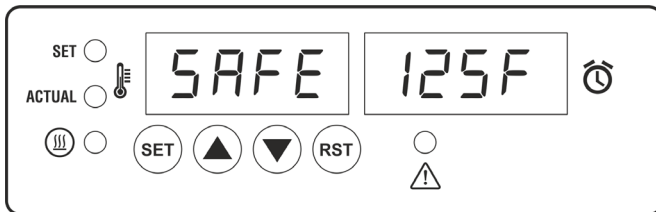

#### 4. Selection of calibration mode

- In this feature, user can select calibration mode between single point calibration and two point calibration as per their requirement.

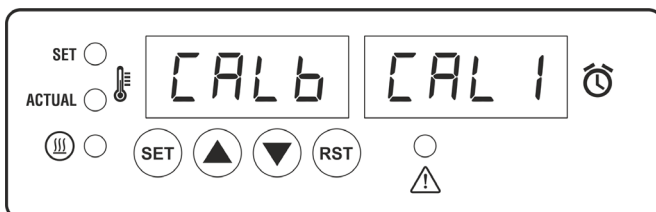

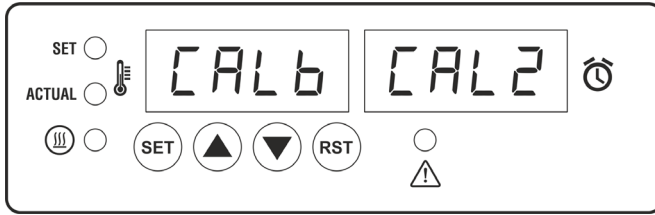

## 5. One point calibration

- In the One point calibration feature, the second display will show raw temperature.
- If the reference thermometer/ Master calibrated device shows 35.4°C or the correct temperature then single press SET button.
- First two values will start blinking then press the decrement button, after setting 34 press SET button to set .4 and value after decimal will start to blink.

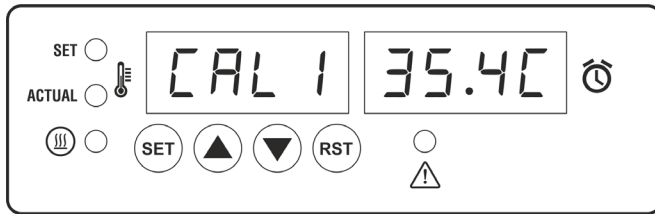

- To save these values press the SET button and display stop blinking and show you the raw temperature value.
- Error calculation is done automatically and it adds in current temperature as the selected value calibration is one point calibration.
- If you don't want to save the values press the RST button until values stop blinking and show you the raw temperature value.

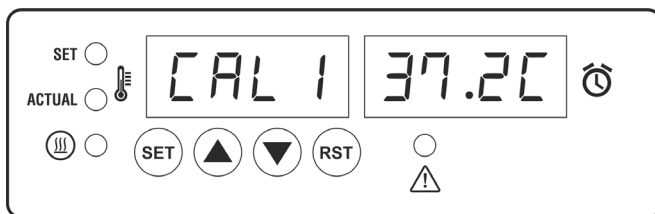

## 6. Two point calibration

- In this feature the user can calibrate at two points, Low point and High point.
- Low points can calibrate between 30°C to 50°C.
- High point can calibrate between Low point of calibration + 10°C to 90°C. However we recommended the high point to be kept lower than 75°C.

### Example

- If the user wants to calibrate the water bath at 45 and 77, select CAL2 feature.

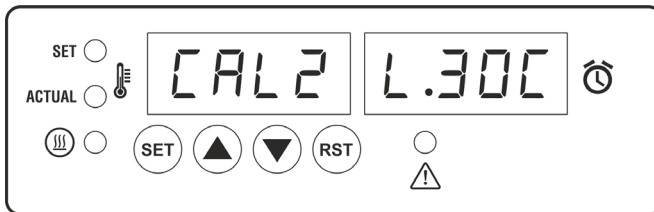

- Press SET button and set low point 45.

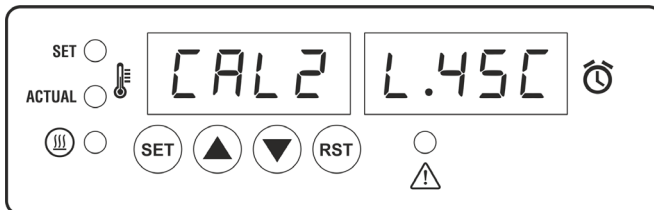

- After setting the low point, press the SET button and high point window will pop up. Set high point 70 and press SET button.

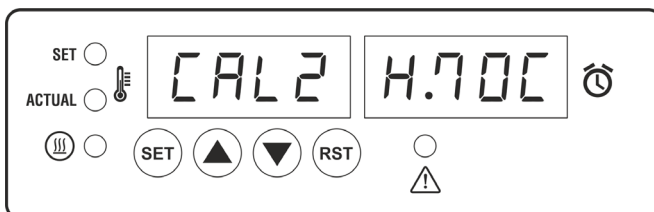

- It starts heating.

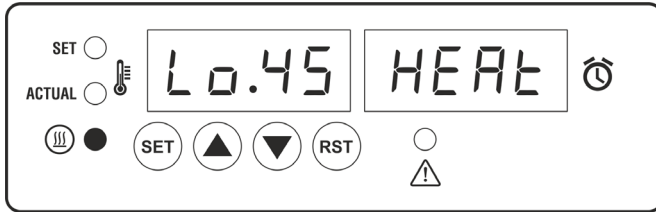

- After reaching a set low point temperature, one display will show the set temperature while the other will show the current temperature and buzzer starts beep and red alarm led is ON.

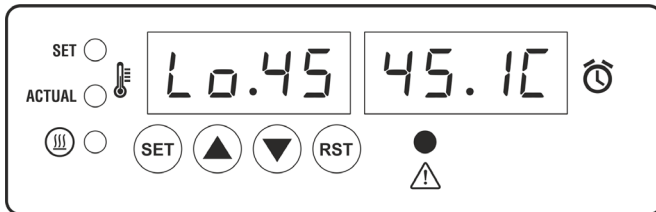

- Press the SET button and put the master's/ calibrated thermometer temperature.

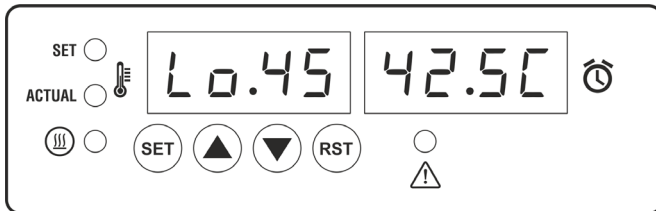

- Press SET button and it starts heating again for set high point temperature.

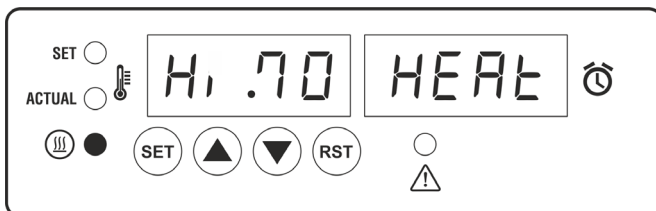

- After reaching a set high point temperature, one display will show the set temperature while the other will show the current temperature and buzzer starts beep and red alarm led is ON.

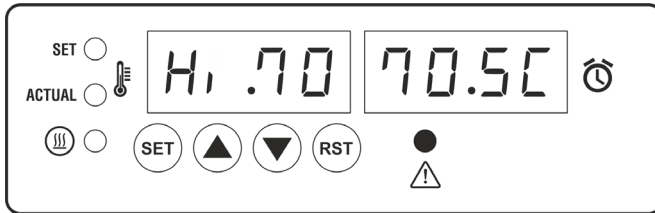

- Press the SET button and put the master's/ calibrated thermometer temperature.

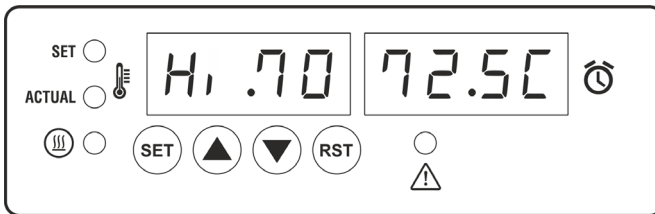

- When the window will show calibrated saved then two point calibration is done successfully.

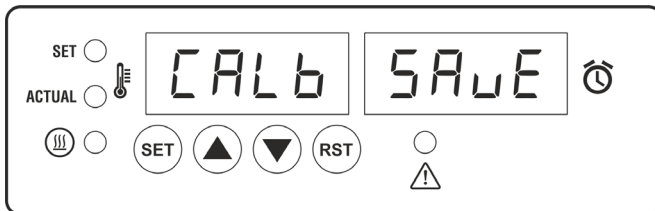

**Note:** If the set temperature is reached and within 30 min there is no interruption from the user then the process automatically turns off.

## 7. Time

### Total Time

- If user select total time then timer starts countdown after starting the process immediately.

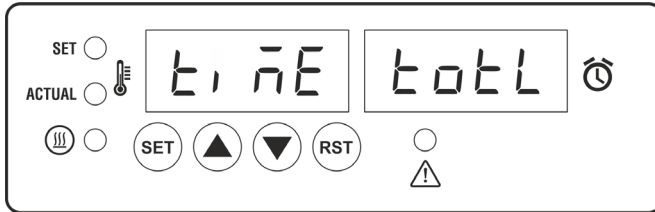

### Soak Time

- If the user selects soak time then timer starts countdown after reaching the set temperature.

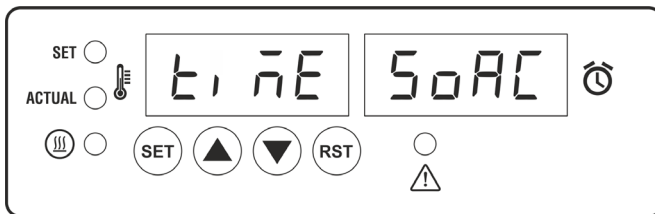

## 8. PID Settings

- For Precise control PID values need to be set.

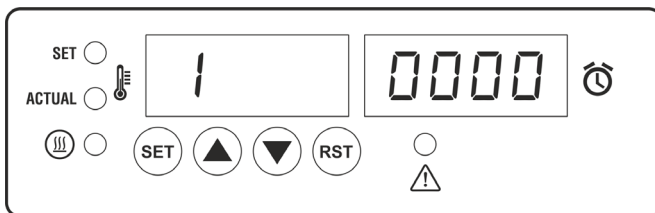
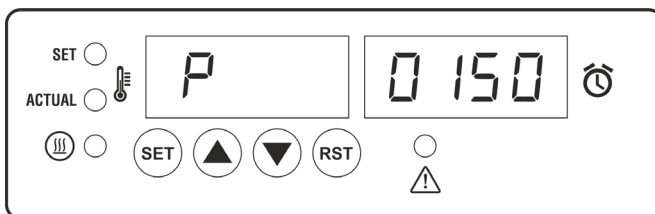

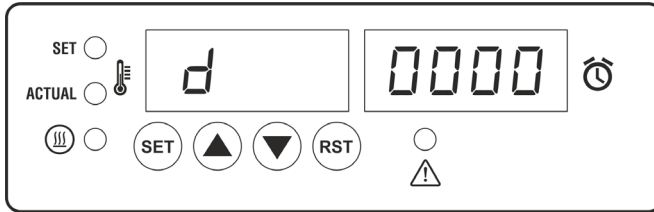

This is a critical setting and should be done only by the service engineer.

## 9. Factory Reset

- This is a factory reset option. If the user selects this option then the product will reset and all by default value of features will be restored. Any existing setting and calibration values will be discard.



Factory reset will discard the safe temperature value, please reinitiate safe temperature value before resuming operation.

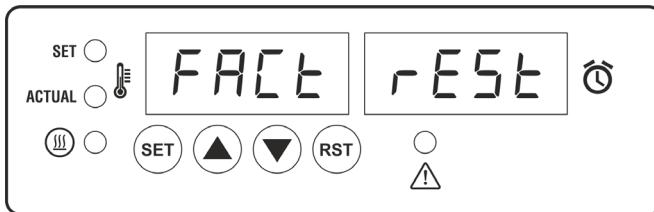

- Press the SET button and it will ask for confirmation for factory reset.

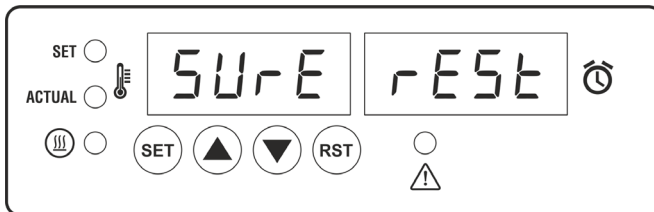

- Press the SET button and reset of the unit will start.

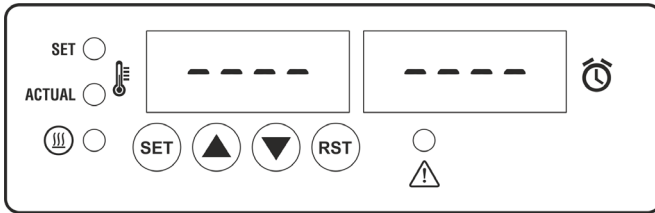

- Reset done window pops up and it goes to the home page after the factory reset is done.

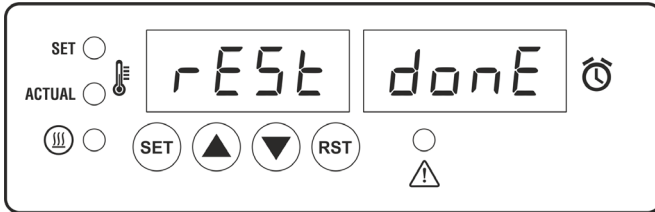

## OPERATIONS OF WLC & WLS SERIES

- Default power ON state - It will check whether the probe is connected or not.
- If probe is connected it displays the current temperature and time, otherwise it will display the probe error.

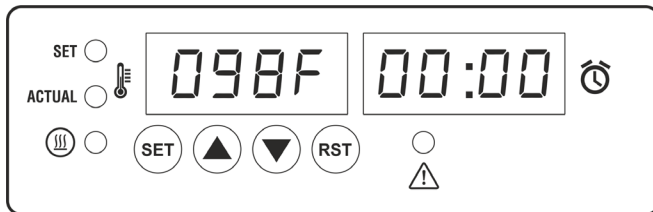
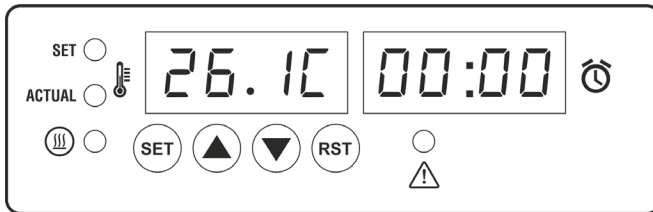

- PRESS SET button to set parameters.
- Use ▲ & ▼ buttons to increase and decrease the set point values.
- User can set
  1. Max. temp 99°C or 212°F .
  2. Max. time (hour:min) 99:59

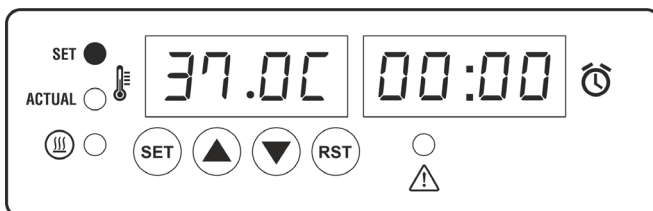

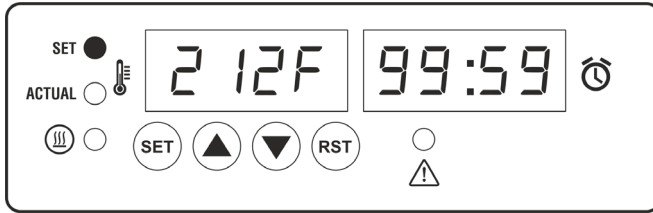

- After setting the time the process starts.
- The process will stop after reaching the set time given by the user.
- If the user set the set time to 00:00 the process will not start.
- Once the process is started, Process window will be shown.
- At the same time Set window will be displayed alternatively.

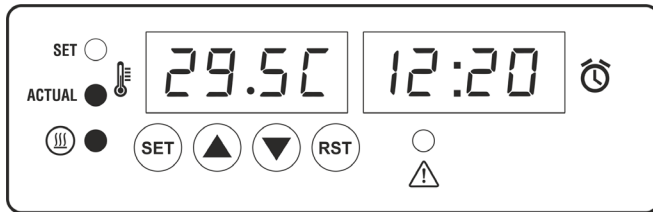
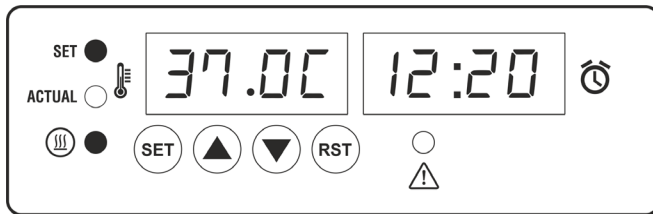

- Above window will show if selected unit is °C.

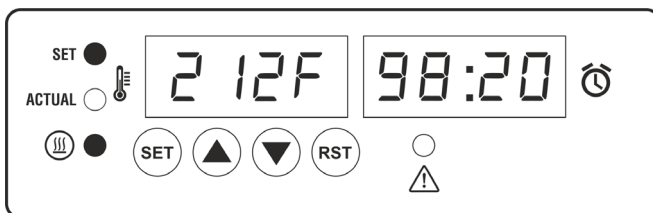

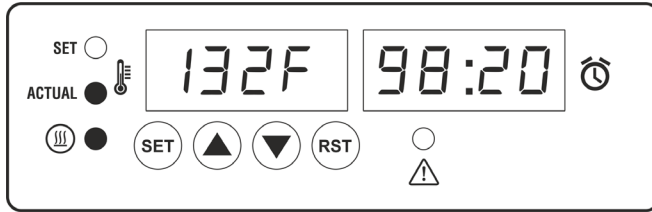

- Above window will show if selected unit is °F.

### FOR WLS SERIES

- User can change the motor status during the process.
- Single press the set button and user can change the motor status by using ▲ or ▼ button.

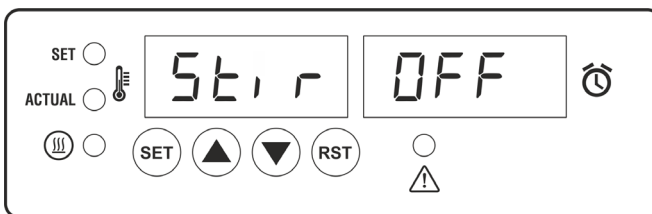
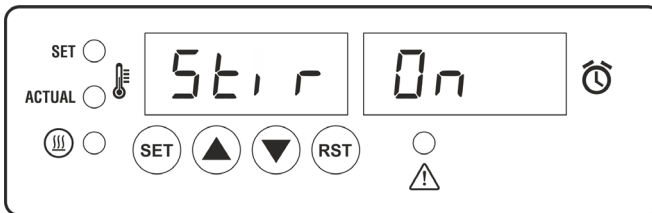

- To save the change status of motor again single press the SET button.
- To discard the change status of motor single press the RST button.

## POP UP ERRORS IN WLC & WLS SERIES

### 1. Probe Error

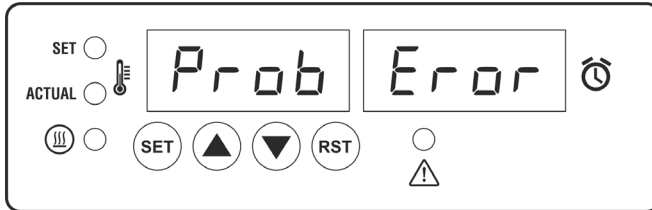

- This display will shown probe error if the probe is open or the probe is defective.
- And buzzer will beep.
- If the error window is displayed by the system during the process (the controller will stop the heating and timer will be paused).
- Connect the probe to continue the process or call service support.

### 2. Fill Bath Error

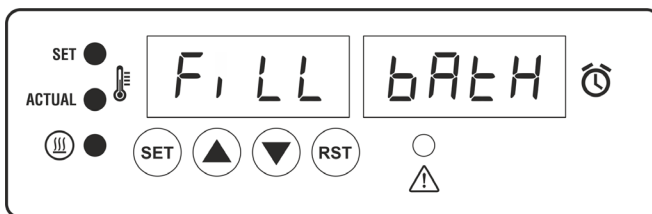

- This display will shown fill bath error if the water tub level is low.
- When process starts, it checks whether water tub level is low or not if and only if the set temperature in °C is ambient +12 °C and in °F ambient +15°F.
- It will pause the process timer and stop heating till the water is upto full level.
- If user want to run water bath in low level then single press the RST button and it will resume the process.

## TROUBLESHOOTING

S.NO.	PROBLEM	SOLUTION
1.	The unit is not turning ON	<ul style="list-style-type: none"> <li>• Check the supply in AC mains.</li> <li>• Make sure power cable is inserted to the socket properly.</li> <li>• Check whether the main switch is ON or OFF.</li> <li>• Ensure the main switch is ON.</li> <li>• Check if the unit is heating and rthe switch is not illuminating, the switch needs to replace.</li> <li>• If the unit is not heating, please check the fuse.</li> </ul>
2.	If the fuse is blown	<ul style="list-style-type: none"> <li>• Switch OFF the unit and remove power cable from AC mains.</li> <li>• Unscrew the red cap on the fuse holder.</li> <li>• Remove the glass tube fuse.</li> <li>• Check if the fuse if blown.</li> <li>• If the fuse is blown, replace it with the new fuse which is mentioned in the check list.</li> </ul>
3.	No or low heating	<ul style="list-style-type: none"> <li>• Ensure the unit is ON.</li> <li>• Ensure the temperature controller is not set at zero. (Temperature controller shows OUT indication if the heater supply is ON)</li> <li>• If the heating power id lower than previous noticed value for tempertaure controller, it may be damaged.</li> <li>• If the problem persists, please contact Borosil Service Center.</li> </ul>





## WARRANTY REGISTRATION

Please handover this registration form to the distributor from where you have purchased this product. The warranty is valid only when this warranty registration form is received by us within 30 days from the date of purchase.

Product: **ELEMENTAL SERIES WATER BATH**

WLS020

WLC020

Product Sr. No.: \_\_\_\_\_

WLS012

WLC012

Date of Invoice: \_\_\_\_\_

WLS005

WLC005

Invoice No.: \_\_\_\_\_

### Customer name & address

Name : \_\_\_\_\_

\_\_\_\_\_

Address: \_\_\_\_\_

\_\_\_\_\_

\_\_\_\_\_

Telephone: \_\_\_\_\_

E-mail: \_\_\_\_\_

### Customer sign & seal

### Dealer name & address

Name : \_\_\_\_\_

\_\_\_\_\_

Address: \_\_\_\_\_

\_\_\_\_\_

\_\_\_\_\_

Telephone: \_\_\_\_\_

E-mail: \_\_\_\_\_

### Dealer sign & seal



# BOROSIL® Scientific

**STATEMENT OF WARRANTY**

Borosil confirms that this product has been manufactured in accordance with our technical specifications and quality requirements.

- Borosil warrants the product from manufacturing and workmanship defects for a period of 12 months from the date of invoice.
- Warranty is void, if apparatus is not operated as prescribed in the operating manual supplied along with the unit.
- To be covered under warranty.
  - » Units have to be connected to standard 230V 50Hz, 15A wall sockets with proper earthing for WLS020 and WLC020.
  - » Units have to be connected to standard 230V 50Hz, 6A wall sockets with proper earthing for WLS012, WLC012, WLS005 and WLC005.
  - » Corrosion damage to the tank due to spillage of chemical will not be covered under warranty.
  - » Warranty does not cover replacement of heating element more than once.
  - » Warranty does not cover corrosion and physical damage due to environmental condition at the installed site or due to improper handling.

**Terms:**

- » In the event of malfunction due to defect, the buyer will have to follow the Borosil’s service process.
- » Certain units can not be serviced / rectified at the buyer’s place and the units may have to be brought to Borosil’s service center as advised by Borosil’s representatives.
- » In no event shall Borosil be liable for consequential or incidental damages.

<b>INVOICE DATE</b>	<b>BUYER</b>	<b>AFFIX SERIAL NUMBER</b>
<b>INVOICE#</b>		
<b>Dealer name &amp; address</b>		<b>Dealer sign &amp; seal</b>

**BOROSIL SCIENTIFIC LIMITED**

Corporate Office : 1101, Crescenzo G-Block, Opp. MCA Club, Bandra Kurla Complex, Bandra (E), Mumbai-400051, India.



**: MANUFACTURED BY :**

**Borosil Scientific Limited**

Plot No.7, Sr. No. 234, 235 & 245,  
Indialand Global Industrial Park,  
Hinjewadi Phase 1, Pune - 411057

*Write to us on above address.*

**: MARKETED BY :**

**Borosil Scientific Limited**

1101, G-Block, Parinee Crescenzo,  
BKC, Bandra East, Mumbai - 51

Maharashtra, India

**: CUSTOMER CARE CONTACT :**

**Phone : 1800 22 4551 | Email : [lab.support@borosil.com](mailto:lab.support@borosil.com)**

**Website : [www.borosilscientific.com](http://www.borosilscientific.com)**