

**LABQUEST**  
BY **BOROSIL®**

# WATER BATH

## OPERATING MANUAL

**WBP012**

**WBP015**

**WBP020**

**WBP024**

**WBP035**

**WBP060**

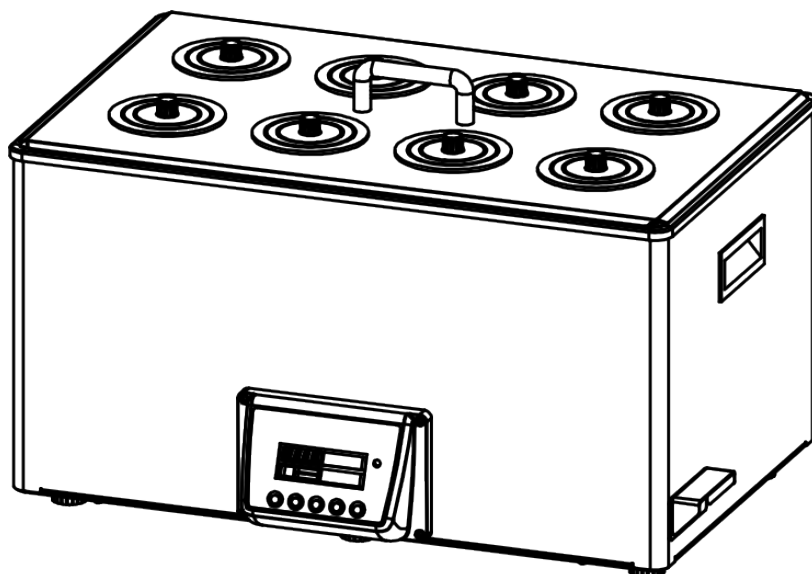

**DEALER :**



## THANK YOU NOTE

*We Borosil, one of India's most customer oriented brands truly appreciate your business and express our gratitude for the trust you have placed on us.*

*We hope your choice serves you well in your scientific endeavors and aspire to have the pleasure of doing business with you for years to come.*



## TABLE OF CONTENTS

<b>Sr. No.</b>	<b>Particular</b>	<b>Page No.</b>
1.	Packing List.....	7
2.	Product Specification.....	8
3.	Safety and Warning.....	11
4.	Unboxing of the product.....	13
5.	Product Identification.....	14
6.	Setting Up.....	18
7.	First Time Operation.....	19
8.	General Operating Instructions.....	20
9.	Description of Buttons & Functions.....	21
10.	Operations of WBP Series.....	22
11.	Features of WBP Series.....	24
12.	User Menu.....	25
13.	Service Menu.....	32
14.	Pop-up Errors & Warnings.....	40
15.	Troubleshooting.....	41
16.	Warranty Registration.....	43
17.	Statement of Warranty.....	45
18.	Contact Information.....	48



## PACKING LIST

1. Perforated tray .....01 No.
2. Ring set
  - a) WBP024 / WBP020 .....08/12 Nos.
  - b) WBP012 .....06 Nos.
3. Leveling shoes
  - a) WBP024 / WBP020 .....06 Nos.
  - b) WBP035 / WBP060 .....06 Nos.
  - c) WBP012 / WBP015 .....04 Nos.
4. Operating Manual .....01 No.
5. Cap .....01 No.
6. External probe (PT100) .....01 No.
7. Stir bar
  - a) WBP060 / WBP035 .....02 Nos.
  - b) WBP024 / WBP020 .....01 No.
  - c) WBP015 / WBP012 .....01 No.
8. Fuse
  - a) WBP060 / WBP035 - 15 Amps .....02 Nos.
  - b) WBP024 / WBP020 - 10 Amps .....02 Nos.
  - c) WBP015 / WBP012 - 5 Amps .....02 Nos.
9. Power Cable .....01 No.

## PRODUCT SPECIFICATION OF WBP035 / WBP060

<b>PARAMETERS</b>	<b>WBP035</b>	<b>WBP060</b>
Internal dimensions (WxDxH)	650mm x 530mm x 150mm	650mm x 530mm x 200mm
Unit External Dimensions (WxDxH)	660mm x 618mm x 420mm	660mm x 618mm x 470mm
Mains voltage	220v - 240v	220v - 240v
Current consumption	12A	15A
Power consumptions	3000w	4400w
Temperature range	Ambient to 95°C	Ambient to 95°C
Tank material	SS 304	SS 304
Display	LED	LED
Inbuilt temperature probe	PT-1000	PT-1000
Accuracy in temp.	(+/-) 0.2 Degree	(+/-) 0.2 Degree
No. of flask	12	12
Timer Display	Yes (Max 99hr:59min)	Yes (Max 99hr:59min)
RPM	On/Off	On/Off
Safety temp limit cut off	Yes (99 degree)	Yes (99 degree)
External probe	Yes (PT-1000)	Yes (PT-1000)
Media and sample stirrer	Only media	Only media
Error setting	Yes	Yes
2 point calibration	Yes (40°C & 70°C)	Yes (40°C & 70°C)
Data out	Yes (USB B-type)	Yes (USB B-type)

## PRODUCT SPECIFICATION OF WBP020 / WBP024

<b>PARAMETERS</b>	<b>WBP020</b>	<b>WBP024</b>
Internal dimensions (WxDxH)	528mm x 325mm x 150mm	528mm x 325mm x 200mm
Unit External Dimensions (WxDxH)	546mm x 412mm x 320mm	560mm x 360mm x 300mm
Mains voltage	220v - 240v	220v - 240v
Current consumption	10A	10A
Power consumptions	2000w	2000w
Temperature range	Ambient to 99°C	Ambient to 99°C
Tank material	SS 304	SS 304
Display	LED	LED
Inbuilt temperature probe	PT-1000	PT-1000
Accuracy in temp.	(+/-) 0.2 Degree	(+/-) 0.2 Degree
No. of flask	8	8
Timer Display	Yes (Max 99hr:59min)	Yes (Max 99hr:59min)
RPM	On/Off	On/Off
Safety temp limit cut off	Yes (99 degree)	Yes (99 degree)
External probe	Yes (PT-1000)	Yes (PT-1000)
Media and sample stirrer	Only media	Only media
Error setting	Yes	Yes
2 point calibration	Yes (40°C & 70°C)	Yes (40°C & 70°C)
Data out	Yes (USB B-type)	Yes (USB B-type)

## PRODUCT SPECIFICATION OF WBP012 / WBP015

<b>PARAMETERS</b>	<b>WBP012</b>	<b>WBP015</b>
Internal dimensions (WxDxH)	355mm x 325mm x 150mm	355mm x 325mm x 200mm
Unit External Dimensions (WxDxH)	375mm x 340mm x 300mm	375mm x 340mm x 350mm
Mains voltage	220v - 240v	220v - 240v
Current consumption	5A	5A
Power consumptions	900w	900w
Temperature range	Ambient to 99°C	Ambient to 99°C
Tank material	SS 304	SS 304
Display	LED	LED
Inbuilt temperature probe	PT-1000	PT-1000
Accuracy in temp.	(+/-) 0.2 Degree	(+/-) 0.2 Degree
No. of flask	6	6
Probe stand Provision	Yes	Yes
Timer Display	Yes (Max 99hr:59min)	Yes (Max 99hr:59min)
RPM	On/Off	On/Off
Safety temp limit cut off	Yes (99 degree)	Yes (99 degree)
Low water level sensor	Yes	Yes
External probe	Yes (PT-1000)	Yes (PT-1000)
Media and sample stirrer	Only media	Only media
Error setting	Yes	Yes
2 point calibration	Yes (40°C & 70°C)	Yes (40°C & 70°C)
Data out	Yes (USB B-type)	Yes (USB B-type)

## SAFETY AND WARNING



Important operating and maintenance instructions.  
Read the accompanying text carefully.



### Potential Electrical Hazards

- Only qualified persons should perform procedures associated with this equipment.
- Equipment must be turned off and disconnected during maintenance/ service.
- Equipment to be connected to power with proper earthing.
- The manufacturer is not liable for any injury or death resulting from electrical hazards due to faulty supply to the equipment.



Ensure to remove the power plug post power failure.

## SAFETY INSTRUCTIONS

- On long hours of usage the equipment surface may be heated.
- Do not operate the equipment unattended / unsupervised.
- This is a heating equipment hot surfaces may cause burns & materials which may be affected by elevated temperatures.
- The Ceramic wool insulation emits fumes in the first few hours of operation. Ensure proper ventilation during first use.
- Always use proper protective equipments. (Clothing, gloves, goggles, etc.)

- Always follow good hygiene practices.
- Each individual is responsible for his / her own safety.
- Drain the water from the tube only after it reaches to ambient.
- Please note that lowest set value for temperature is ambient +5°C and highest set value is 99°C.
- Do not run the unit without water. Use always distilled water or RO water to avoid scaling.
- Never use cracked or leaking containers inside the bath.
- In case of chemical spillage inside the pan, clean immediately. Drain and clean the bath regularly to prevent organic growth.
- Wipe clean and maintain the bath dry when not in use. Sanitise wipes are recommended.
- Do not keep unit on wet bench top.
- The unit should be plugged to standard 230V, 3 pin, power socket having proper earthing.
- If the water spills on the control box, first switch off the unit and wipe dry. Restart only after unit is dry.
- Do not check the water temperature with your body.



Open the lid during the operation with caution as instant steam release can cause severe burns.

## UNBOXING OF WATERBATH

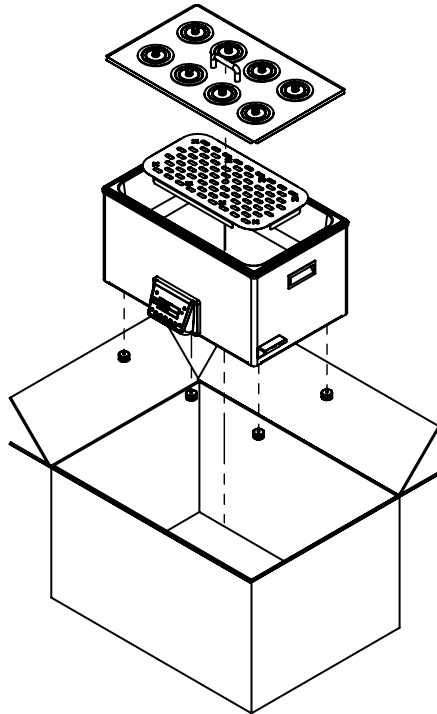

### UNBOXING INSTRUCTION:

1. Remove rubber shoes, external probe, lid, ring set, perforated tray, power cable.
2. Remove the Water Bath unit safely.
3. Any damage at receipt should be reported to the dealer / delivery agent.

**(Read manual before installation on the lab bench.)**

## PRODUCT IDENTIFICATION OF WBP035 / WBP060

- A. HANDLE
- B. CAP
- C. PERFORATED TRAY
- D. LOW WATER LEVEL SENSOR
- E. STIR BAR
- F. CONTROLLER BOX
- G. RUBBER SHOES
- H. FUSE HOLDER
- I. ON/OFF
- J. POWER CABLE
- K. DIN CONNECTOR

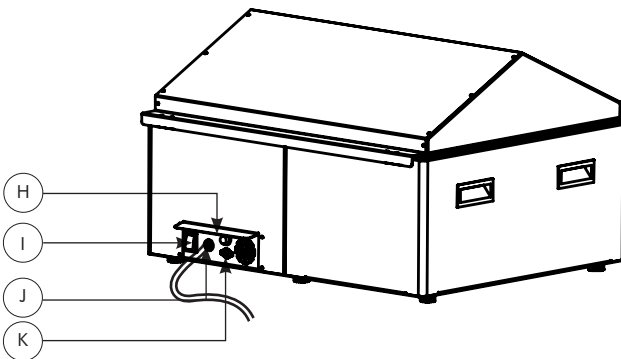
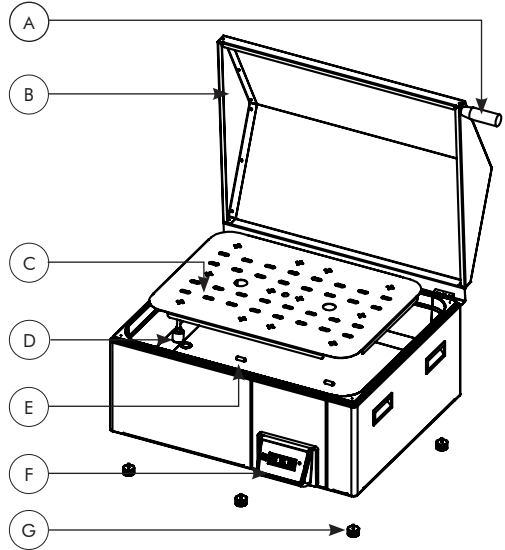

## PRODUCT IDENTIFICATION OF WBP024 / WBP020

- A. RING SET
- B. CAP
- C. HANDLE
- D. PERFORATED TRAY
- E. STIR BAR
- F. CONTROLLER BOX
- G. USB
- H. DIN CONNECTOR
- I. COOLING FAN
- J. ON/OFF
- K. POWER SOCKET
- L. RUBBER SHOES
- M. DRAIN VALVE

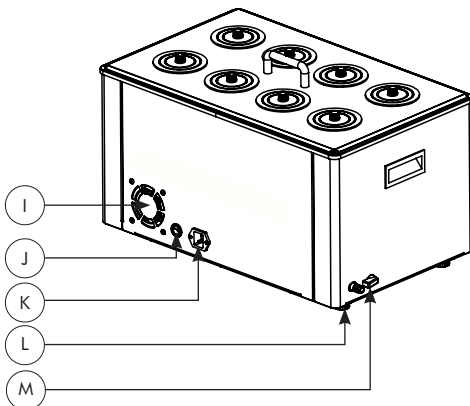
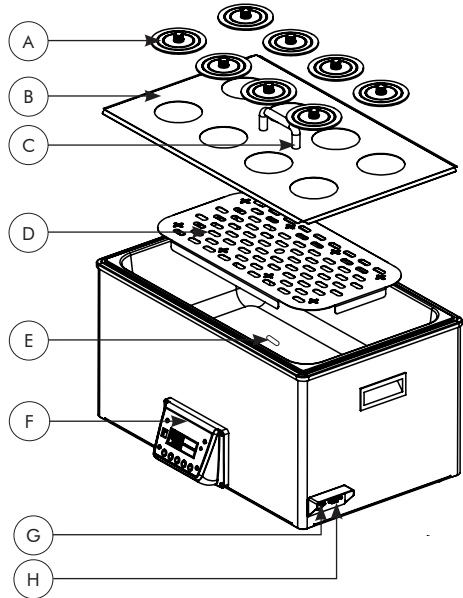

## PRODUCT IDENTIFICATION OF WBP012

- A. RING SET
- B. CAP
- C. HANDLE
- D. PERFORATED TRAY
- E. STIR BAR
- F. CONTROLLER BOX
- G. USB
- H. DIN CONNECTOR
- I. RUBBER SHOES
- J. ON/OFF
- K. POWER SOCKET
- L. COOLING FAN
- M. DRAIN VALVE

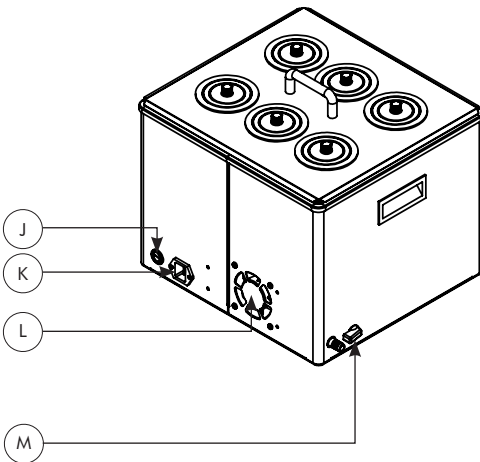
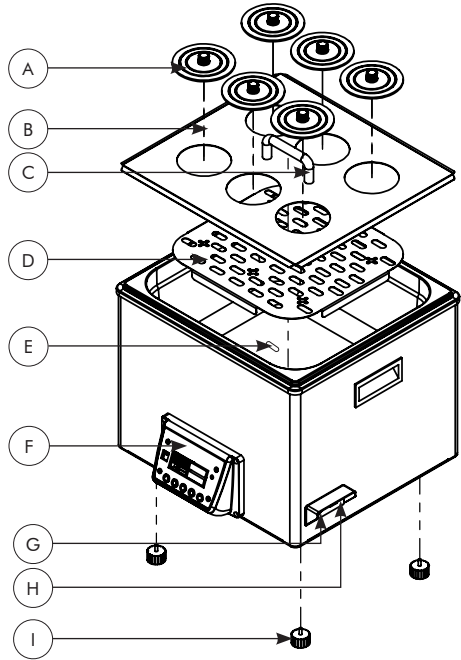

## PRODUCT IDENTIFICATION OF WBP015

- A. CAP
- B. HANDLE
- C. PERFORATED TRAY
- D. STIR BAR
- E. CONTROLLER BOX
- F. USB
- G. DIN CONNECTOR
- H. RUBBER SHOES
- I. ON/OFF
- J. POWER SOCKET
- K. COOLING FAN
- L. DRAIN VALVE

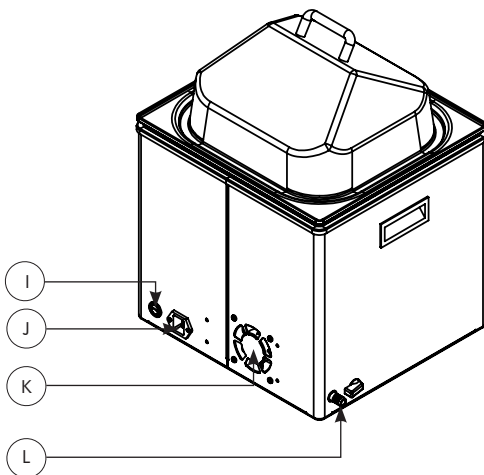
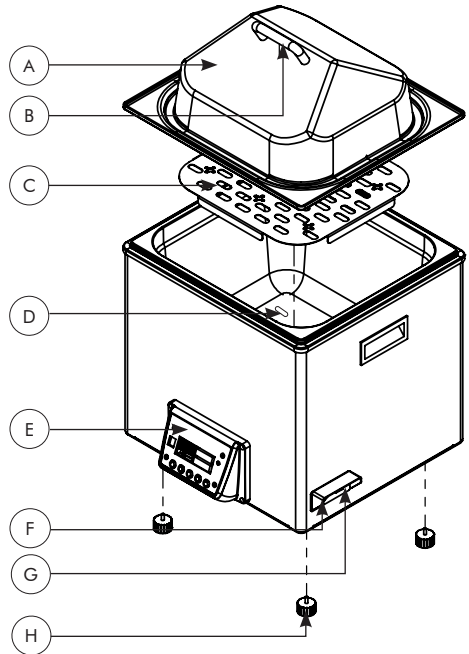

## SETTING UP

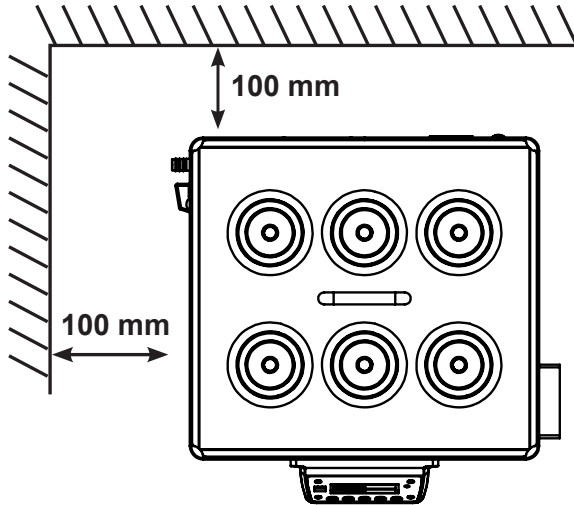

Figure: 18.1

1. Insert the leveling shoes at the base and tighten it.
2. Make sure that minimum 100 mm gap is maintained between body and wall as shown in fig. 17.1
3. Ensure that the power switch is in "OFF" position.
4. Please ensure there is a fuse in the fuse holder.
5. Connect the male end of power cable to the wall socket.
6. The unit is ready to operate for first usage.

## FIRST TIME OPERATION

1. Connect the power supply to a properly earthed power socket.
2. Fill the water till the filling step in the tank.
3. Switch ON the wall power socket.
4. Switch ON the red illuminated switch which is given on the back side of the unit.
5. Set the temperature to 90°C. (SETTING THE TEMP. EXPLAINED IN OPERATION OF THE WBP SERIES).



### CAUTION !

6. Once the process started, user can see the temperature rising in the display.
7. Please ensure adequate ventilation is proper during first operation for protection from fumes emitted by Ceramic insulation.
8. Check whether the current is flowing in the body by using a tester, do not touch the unit by bare hands.



### WARNING !

9. If the tester lights, switch off the unit and remove the power cable from the wall and check earthing. If the problem persist, do not operate the unit and please contact Borosil Service Center.
10. Once the fumes are reduced (normally past 5 minutes to 10 minutes of operation), set temperature to approx ambient temp. and switch OFF.
11. Allow the unit cool to ambient temperature.
12. Now the unit is ready for regular usages.

## GENERAL OPERATING INSTRUCTIONS

1. Keep the stir bar at the center of the tub.
2. Place the perforated tray inside the tub.
3. Pour the distilled water till the brim of the tank.
4. Place the conical flask on the perforated tray (follow the guiding marks on the perforated tray).
5. Place the cap on the unit with ring set, in the position.
6. Fix the retort stand for installing the apparatus.
7. Please make sure that the weight is balanced after connecting the apparatus in retort stand.
8. Switch ON power.
9. Set the desired temperature by using controller ( Min Ambient+5<sup>o</sup>, Max 99<sup>o</sup>).
10. Do not pour or spill the liquid on the control box. If any water drop falls, wipe it with the dry cloth.
11. It is recommended to set the ambient temp. before switching it off.
12. The motor will start after few seconds, this is because of the viscosity of fluid. Viscous fluids opposes stirring action, after few seconds the motor will start, as increase in the ramp rate.
13. After operation it is recommended drain the water from the tub.

## DESCRIPTION OF BUTTONS & FUNCTIONS

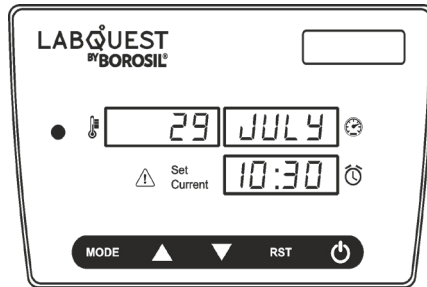

### 1. **MODE :**

- **Single press** selects the parameter which needs to be mode and also to start the process.
- **Long press** is used to enter in to the setting menu.

### 2. **UP (▲) :**

- To increase the set point values and to scroll up the setting menu.

### 3. **DOWN (▼) :**

- To decrease the set point values and to scroll down the setting menu.

### 4. **RESET (⊖) :**

- **Single press** used to go back to previous state (back function) and to exit from settings mode.
- **Long press** used to exit from the settings menu and to stop the process.

### 5. **POWER (⏻) :**

- To ON and OFF the system. (The buzzer will beep each time when the buttons are operated.)

## OPERATIONS OF WBP SERIES

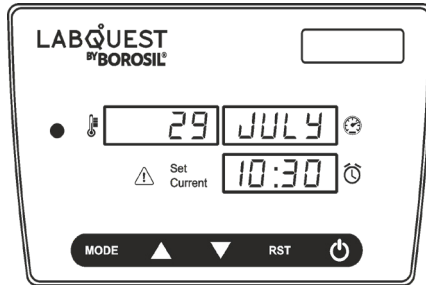

- On default, power on condition display will show day, month and time.
- All LED will be off.
- The unit will display previous set parameters on pressing the MODE key once.
- To quick start the process with previous store parameter long press MODE key.

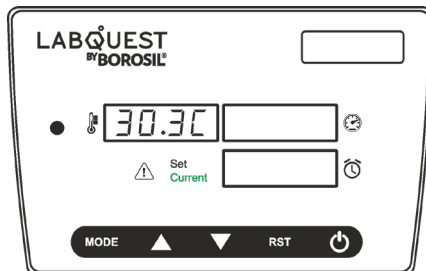

- Single press RST key at homepage and first display will show current temperature for short time.

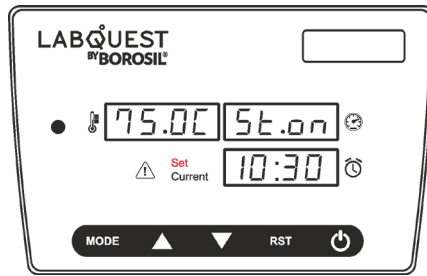

- On pressing the mode key, the set LED will glow and the first two positions of the temperature display will blink.
- On pressing MODE again, the decimal part of the display will blink.
- The user can increment or decrease the parameters by using the arrow keys.
- On pressing the MODE key again, the unit will set the temperature and the stirrer on/off display will start blinking.
- If the user presses mode key once, he can set the time. The hour digits will blink first and the minute digits next.
- If the user presses RST once, it will blink the previous step.
- On pressing MODE again, the unit will store the set parameter and start the process with a long single beep.

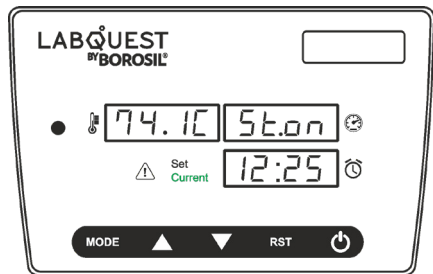
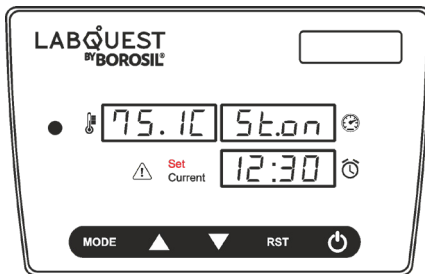

- If the user set the set time to 00:00 the process will not start.
- Once the process is started, Process window will be shown current parameter window.
- At the same time Set window will be displayed alternatively.
- In process time colon (:) will blink.
- After completing the set time, the process will complete and the heater and stirrer will switch off and the display will return to start up screen.
- SET & CURRENT LED will be off.

## FEATURES OF WBP SERIES

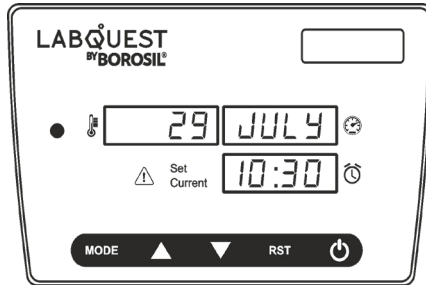

- If user long press MODE key from home page, the unit will enter USER MENU.
- Press ▲ & ▼ key together go into the SERVICE MENU while user in home page.
- To change value of Parameter single press MODE button then second display will start blinking. To change current values press ▲ or ▼ button.
- For save that change values, single press MODE button. Next display will stop blinking and user will see the selected values of parameter on second display.
- If user don't want to change the values of parameter and want the previous selected values of parameter then single press RST button and parameter will stop blinking and user will see the previous selected parameter values on second display.

## USER MENU

### 1. Safe

- In this feature, the user can lock the maximum set temperature.
- To change the value of a parameter, press the MODE key once; to increment the value, use the ▲ and ▼ keys; and to save, press the MODE key once more.
- If the user does not want to save the parameter's edited value, single press the RST key until the settings are restored.
- The user can select a safe value between zero and the maximum value of 99.9°C.

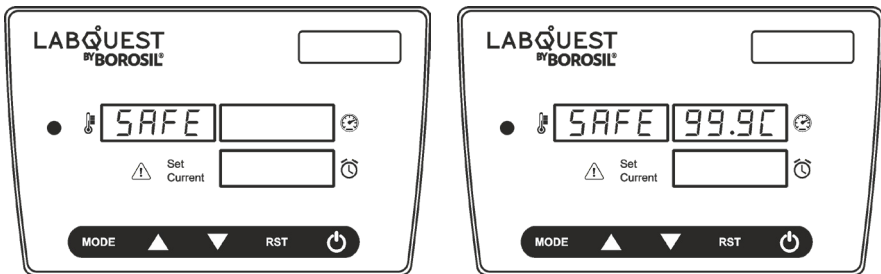

### 2. Calibration Selection

- In CALb mode the unit will select calibration type.
- The user can toggle between CAL1 and CAL2 modes using ▲ & ▼ keys.
- CAL1 will set single point calibration.
- Selecting CAL2 will make the unit work with saved CAL2 values.

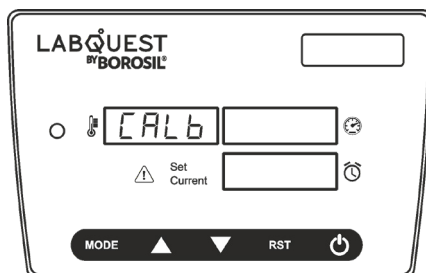

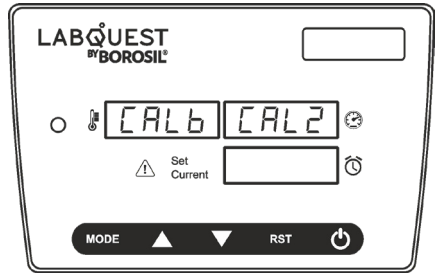
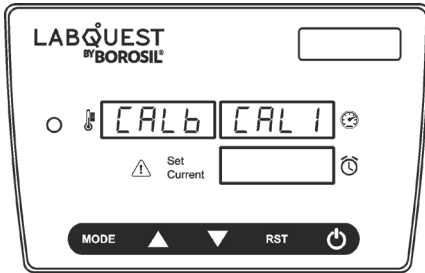

### 3. One Point Calibration

- In the One point calibration feature, the second display will show raw temperature.
- If the reference thermometer/ Meter calibrated device shows 37.20C then single press MODE button.
- First two values will start blinking then press the Increment button, after setting 34 press MODE button to set .2 and value after decimal will start to blink.

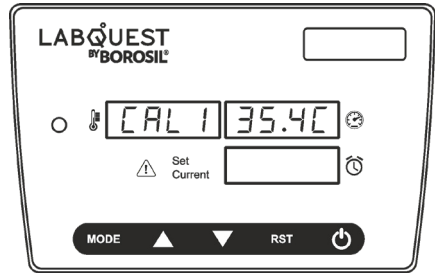

- To save these values press the MODE button and display stop blinking and show you the raw temperature value.
- Error calculation is done automatically and it adds in current temperature as selected calibration is one point calibration.
- If you don't want to save the values press the RST button until values stop blinking and show you the raw temperature value.

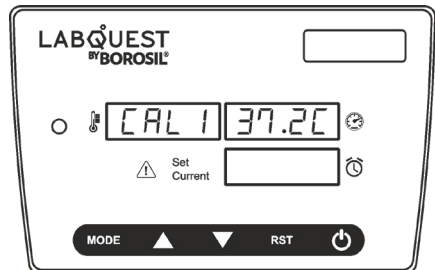

#### 4. Delay Start Function

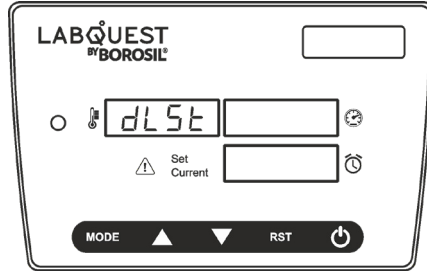

- If user want to start water bath automatically at particular time then user can use this function.
- User can set future time till today or tomorrow till 23:59 time.

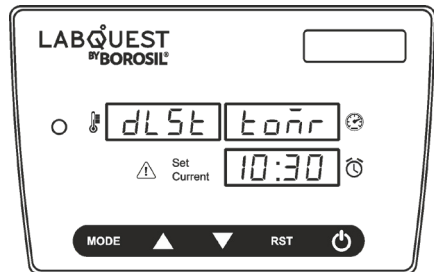
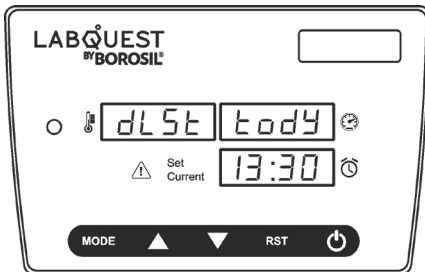

- In delay start, the parameter will show today or tomr on selecting the parameter display.
- After selects the day, user will be asked to set the time. The time will be displayed in 24 hour format only.
- The delay start process will only work in SOCK Time mode i.e. timer count-down start when process temperature reach set temperature.
- Once Time is selected the user will be prompted to select the set parameters.

- User need to set process parameters as mentioned on page no. 23.
- Once user set time parameter then instead of process start system goes into home page.
- System will wait till delay start time reach to start the process.
- To start system with this function automatically system should be powered on.

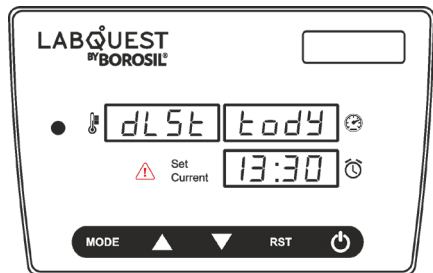
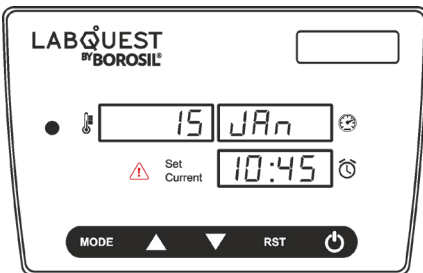
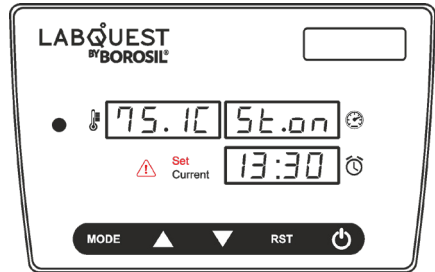

- If delay start function is selected then at home page display between two pages as shown in above image.

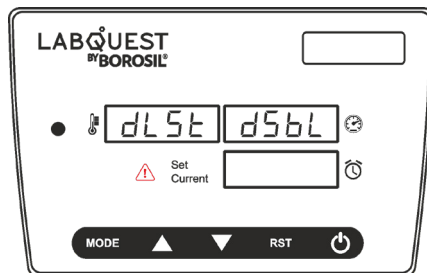

- If user want to terminate delay start function then user need to long press RST key.

## 5. Automatic Process Start

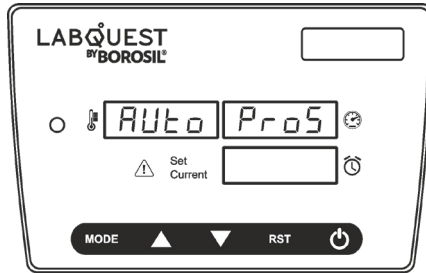

- This function is used for automatically start process after power on if on going process interrupted due to power cut off.

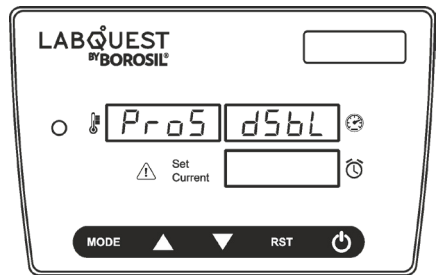
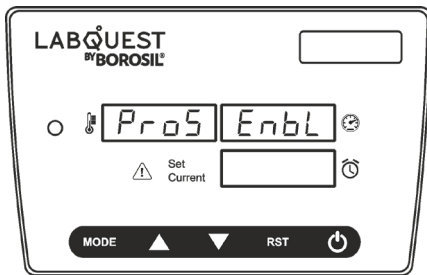

- This function activated if user selected enable (Enbl) and if disable (dSBL) is selected then process is not going to start automatically.

## 6. Time

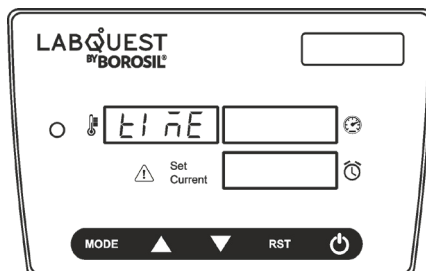

## Total Time

- If user select total time then timer starts countdown after starting the process immediately.

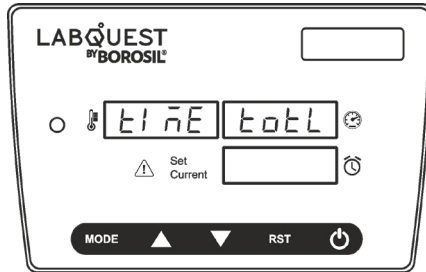

## Soak Time

- If the user selects sock time then timer starts countdown after reaching the set temperature.

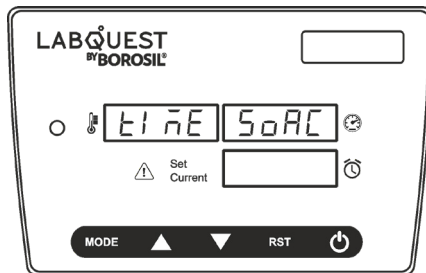

## SERVICE MENU

### 1. Two Point Calibration

( NOT RECOMMENDED OTHER THAN BOROSIL SERVICE ENGINEER )

**Note:** Before decimal point the user can set the value in increment of 1, whereas the user can set the number in increment 0.1 after the decimal point.

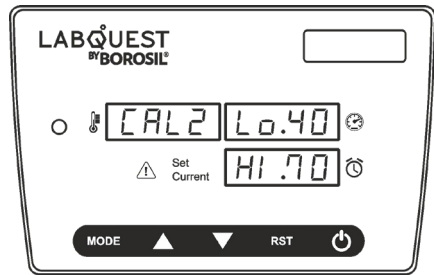
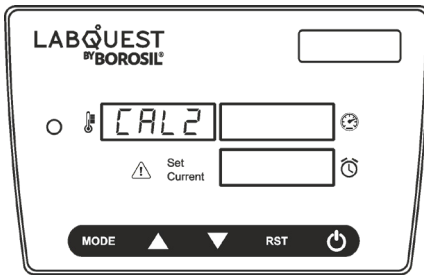

- Set low set temperature of 2 point calibration and single press mode key.
- After this using ▲ & ▼ key set high set temperature of 2 point calibration.
- Single press mode key and heating process will start to achieve low set temperature.
- SET & CURRENT LED will be off and heater LED will on.

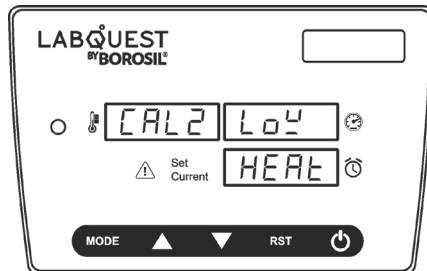

- Till reach low set point, display will show "LOW HEAT"
- PID will try to achieve set point.
- Heater LED will turn on.

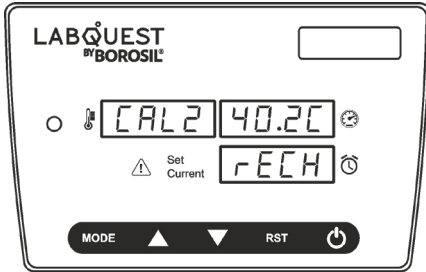

- After single press mode key, first 2 digit of 2<sup>nd</sup> display will start blinking, then allow user to enter Master / thermometer Temperature.
- After putting first 2 digit temperature, press again MODE button then after decimal point will start blinking and then put master/ thermometer reading and press again MODE button.

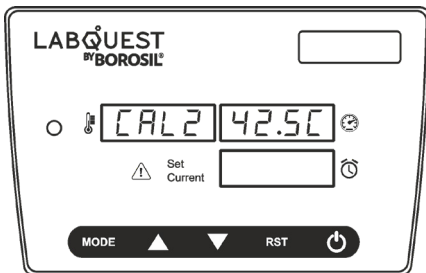

- When set temperature reach, 2<sup>nd</sup> display will show current raw temperature and 3<sup>rd</sup> display will flash "Reach".
- PID will try to maintain set point till user press MODE key or for 30 min.
- If user single press mode key, It go in edit mode otherwise terminate the complete process and will go in home page.

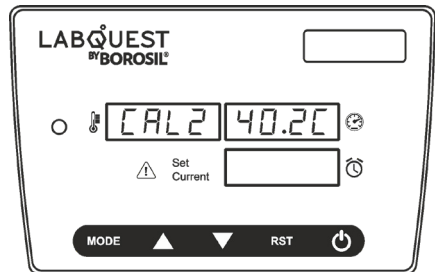

- E.g. If Master / thermometer Temperature shows the temperature 42.5 then using ▲ key increment value and put 42 on first two digits.
- After putting first 2 digit temperature, press again MODE button then after decimal point will start blinking and then put master/ thermometer reading and press again MODE button.
- Process will shift to the next process and try to achieve high set temperature.

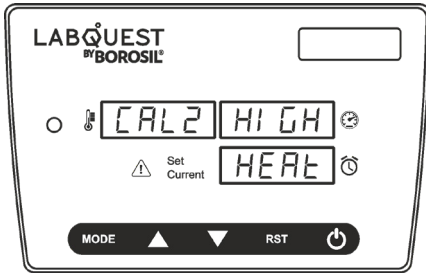

- Till reach High set point, display will show "HIGH HEAT"
- PID will try to achieve set point.
- Heater LED will turn on.

- When set point reach, 2<sup>nd</sup> display will show current raw temperature and 3<sup>rd</sup> display will flash "rECh"
- PID will try to maintain set point till user press MODE key or for 30 min.
- If user single press mode key, It go in edit mode otherwise terminate the complete process and will go in home page
- Heater LED will turn on and also alarm LED.

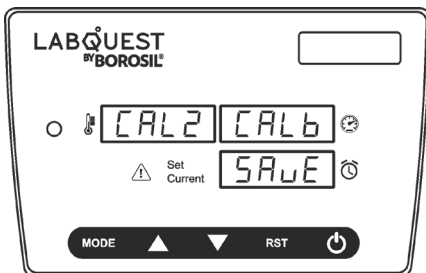
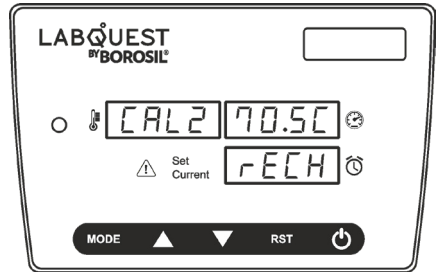

- Single press MODE key to save the calibration.
- Display will display CAL2 calb save and after saving master's temperature system goes to the home page.

## 2. Date and Time Adjustment

- If WBP home page doesn't show exact date, month, time then user can go into this menu and adjust the parameter.

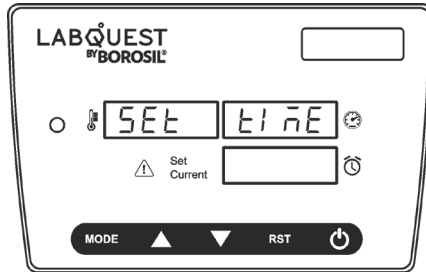

- Single press MODE key then user enter into menu edit mode.
- First parameter blinking allow to edit YEAR parameter.
- After edit year single press MODE key then next two digit start blinking which allow user to set DATE.
- Single press MODE key then user will go to edit MONTH.
- After editing month single press MODE key then system allow user to edit TIME in HOURS and then in MINUTE.
- To save this parameter successfully please single press MODE key after editing time in minutes.

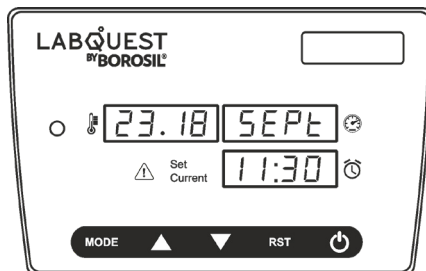

### 3. Rpm

- This parameter is provided as different capacity waterbath has different stirrer bar.
- Every stirrer bath need different power.
- To rotate stirrer bar smoothly and noise freely need to adjust this rpm value.
- Default suggested rpm value is 55.

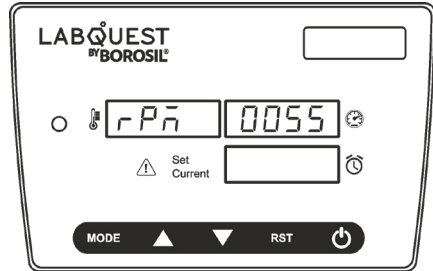
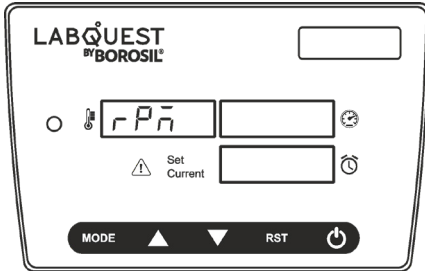

- To edit parameter single press MODE key.
- When user come into the edit parameter second display start blinking, using ⬆ & ⬇ key change parameter and then to save this parameter again single press MODE key.

### 4. Level Sensor override

- This function is provided to override the level sensor in case of failure of level sensor.
- If in case of failure of level sensor if user wants to continue his work smoothly then user can select dSbL option.
- After selection of dSbL option WBP will not create "FiLL bAth Eror" and start the process.

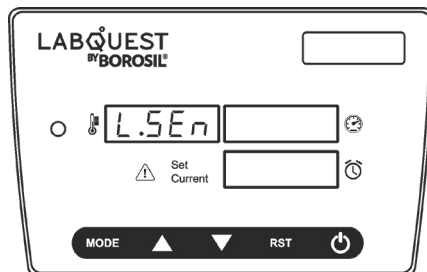

- To detection of water level need to select EnbL option of this menu.

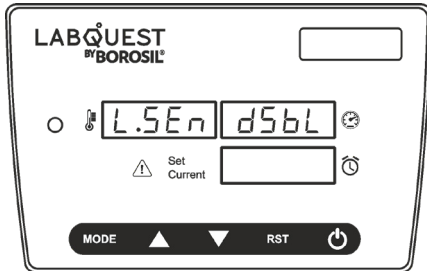

**Note : This option is provided for a time being only, please contact Borosil Service Team after failure of level sensor.**

## 5. Probe Type Selection

- By default WBP used internal probe.
- To use external probe user need to connect external probe and as well as need to select probe type "Etrn" otherwise WBP will continuous process with internal probe.

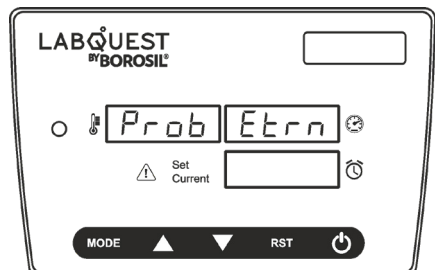
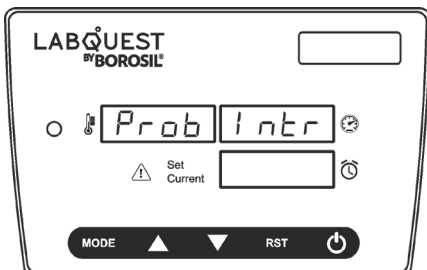
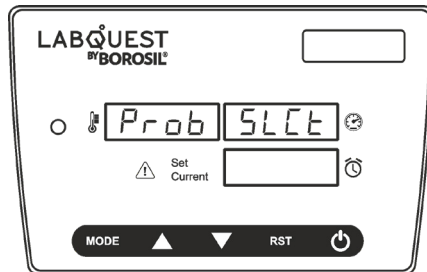

## 6. Factory Reset

- This is a factory reset option. If the user selects this option then the product will reset and all by default value of features will be restored and calibration value will be discarded.

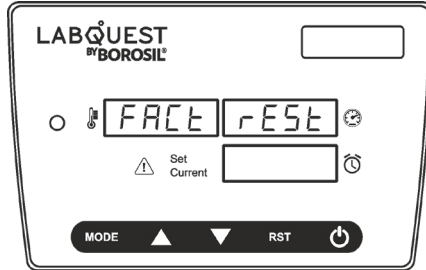

- Press the MODE button and it will ask for confirmation for factory reset.

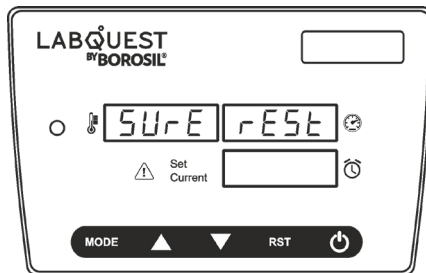

- Press the MODE button and reset of the unit will start.

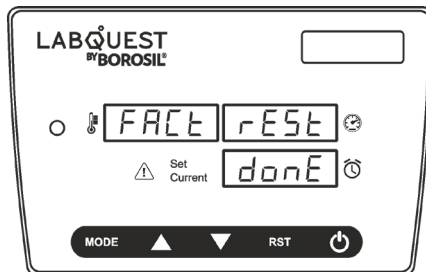

- Reset done window pops up and it goes to the home page after the factory reset is done.

## 7. Log

- This is non editable option.
- In this menu display will show tentative run time of process in hours and days which used to trace life cycle of heater.
- If hours are greater than 999d then days incremented by 1 that is A001 and days will reset to 000d.

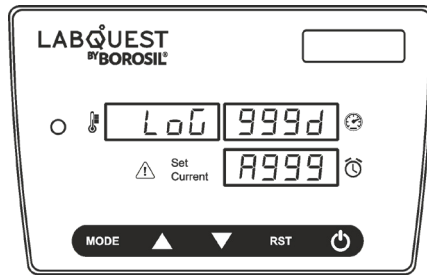

## POP-UP ERRORS AND WARNINGS

### 1. HOT

- Post completion of process, if the bath temperature is higher than 50°C, the unit will display Hot and temperature.
- The ALARM LED will Glow.
- On reaching a temperature below 50°C, the unit will start showing the Date and Time.

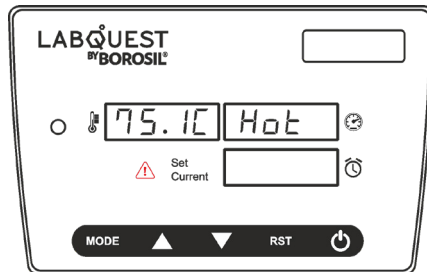

### 2. Fill Bath Error

- This window will pop-up if the water level is low.
- When process starts, it checks whether water level is low or not.
- If water level is low then it will pause the process timer and stop heating till the water is upto full level and error will be displayed on screen till water level is low.

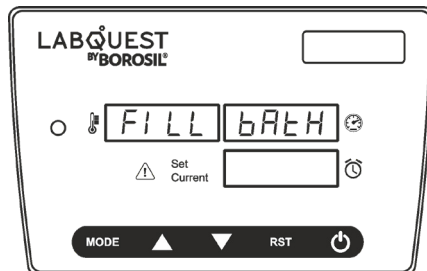

## TROUBLESHOOTING

S.NO.	PROBLEM	SOLUTION
1.	The unit is not turning ON	<ul style="list-style-type: none"> <li>• Check the supply in AC mains.</li> <li>• Make sure power cable is inserted to the socket properly.</li> <li>• Check whether the main switch is ON or OFF.</li> <li>• Ensure the main switch is ON.</li> <li>• Check if the unit is heating and rthe switch is not illuminating, the switch needs to replace.</li> <li>• If the unit is not heating, please check the fuse.</li> </ul>
2.	If the fuse is blown	<ul style="list-style-type: none"> <li>• Switch OFF the unit and remove power cable from AC mains.</li> <li>• Unscrew the red cap on the fuse holder.</li> <li>• Remove the glass tube fuse.</li> <li>• Check if the fuse if blown.</li> <li>• If the fuse is blown, replace it with the new fuse which is mentioned in the check list.</li> </ul>
3.	No or low heating	<ul style="list-style-type: none"> <li>• Ensure the unit is ON.</li> <li>• Ensure the temperature controller is not set at zero. (Temperature controller shows OUT indication if the heater supply is ON)</li> <li>• If the heating power id lower than previous noticed value for tempertaure controller, it may be damaged.</li> <li>• If the problem persists, please contact Borosil Service Center.</li> </ul>





## WARRANTY REGISTRATION

Please handover this registration form to the distributor from where you have purchased this product. The warranty is valid only when this warranty registration form is received by us within 30 days from the date of purchase.

Product: WATER BATH

WBP012     WBP015     WBP020     Product Sr. No.: \_\_\_\_\_

WBP024     WBP035     WBP060     Date of Invoice: \_\_\_\_\_

Invoice No.: \_\_\_\_\_

### Customer name & address

Name : \_\_\_\_\_

Address: \_\_\_\_\_

Telephone: \_\_\_\_\_

E-mail: \_\_\_\_\_

### Customer sign & seal

### Dealer name & address

Name : \_\_\_\_\_

Address: \_\_\_\_\_

Telephone: \_\_\_\_\_

E-mail: \_\_\_\_\_

### Dealer sign & seal



# BOROSIL® Scientific

**STATEMENT OF WARRANTY**

Borosil confirms that this product has been manufactured in accordance with our technical specifications and quality requirements.

- Borosil warrants the product from manufacturing and workmanship defects for a period of 12 months from the date of invoice.
- Warranty is void, if apparatus is not operated as prescribed in the operating manual supplied along with the unit.
- To be covered under warranty.
  - » Units have to be connected to standard 230V 50Hz, 15A wall sockets with proper earthing for WBP012, WBP015, WBP020, WBP024, WBP035 & WBP060.
  - » Corrosion damage to the tank due to spillage of chemical will not be covered under warranty.
  - » Warranty does not cover replacement of heating element more than once.
  - » Warranty does not cover corrosion and physical damage due to environmental condition at the installed site or due to improper handling.

**Terms:**

- » In the event of malfunction due to defect, the buyer will have to follow the Borosil’s service process.
- » Certain units can not be serviced / rectified at the buyer’s place and the units may have to be brought to Borosil’s service center as advised by Borosil’s representatives.
- » In no event shall Borosil be liable for consequential or incidental damages.

<b>INVOICE DATE</b>	<b>BUYER</b>	<b>AFFIX SERIAL NUMBER</b>
<b>INVOICE#</b>		
<b>Dealer name &amp; address</b>		<b>Dealer sign &amp; seal</b>

**BOROSIL SCIENTIFIC LIMITED**

Corporate Office : 1101, Crescenzo G-Block, Opp. MCA Club, Bandra Kurla Complex, Bandra (E), Mumbai-400051, India.







**: MANUFACTURED BY :**

**Borosil Scientific Limited**

Plot No.7, Sr. No. 234, 235 & 245,  
Indialand Global Industrial Park,  
Hinjewadi Phase 1, Pune - 411057

Write to us on above address.

**: MARKETED BY :**

**Borosil Scientific Limited**

1101, G-Block, Parinee Crescenzo,  
BKC, Bandra East, Mumbai - 51

Maharashtra, India

**: CUSTOMER CARE CONTACT :**

Phone : 1800 22 4551 | Email : [lab.support@borosil.com](mailto:lab.support@borosil.com)

Website : [www.borosilscientific.com](http://www.borosilscientific.com)