

**LABQUEST**  
BY **BOROSIL®**

# OIL BATH

## OPERATING MANUAL

### NON CIRCULATING OIL BATH

**OMC250**

**OMC010**

### CIRCULATING OIL BATH

**OMS250**

**OMS010**

**OMS020**

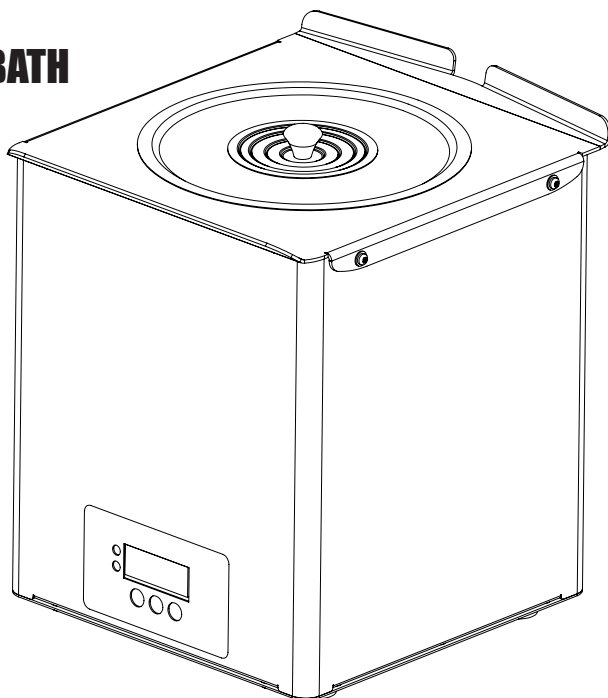

**DEALER :**



**THANK YOU NOTE**

*We Borosil, one of India's most customer oriented brands truly appreciate your business and express our gratitude for the trust you have placed on us.*

*We hope your choice serves you well in your scientific endeavors and aspire to have the pleasure of doing business with you for years to come.*



## TABLE OF CONTENTS

<b>Sr. No.</b>	<b>Particular</b>	<b>Page No.</b>
1.	Packing list of OMC250 & OMC010.....	7
2.	Packing list of OMS250, OMS010 & OMS020.....	8
3.	Product specification of OMC250.....	9
4.	Product specification of OMC010.....	10
5.	Product specification of OMS250.....	11
6.	Product specification of OMS010.....	12
7.	Product specification of OMS020.....	13
8.	Safety and warning.....	15
9.	Product identification.....	17
10.	Installation on lab bench.....	18
11.	Operating the OMS & OMC units.....	19
12.	Setting the temperature and speed.....	21
13.	Settings of OMS.....	22
14.	Working of OMS.....	23
15.	Settings of OMC.....	27
16.	Working of OMC.....	28
17.	Features of OMS & OMC.....	30
18.	Accessories.....	35
19.	Troubleshooting.....	36
20.	Warranty registration.....	38
21.	Statement of warranty.....	39
22.	Contact information.....	40



### **PACKING LIST OF OMC250**

1. Perforated tray..... 1 No.
2. Ring set..... 1 No.
3. Power Cable..... 1 No.
4. External probe..... 1 No.

### **PACKING LIST OF OMC010**

1. Perforated tray..... 1 No.
2. Ring set..... 1 No.
3. Power Cable..... 1 No.
4. External probe..... 1 No.

### PACKING LIST OF OMS250

1. Perforated tray..... 1 No.
2. Ring set..... 1 No.
3. Power Cable..... 1 No.
4. External probe..... 1 No.
5. Stirr bar..... 1 No.

### PACKING LIST OF OMS010

1. Perforated tray..... 1 No.
2. Ring set..... 1 No.
3. Power Cable..... 1 No.
4. External probe..... 1 No.
5. Stirr bar..... 1 No.

### PACKING LIST OF OMS020

1. Perforated tray..... 1 No.
2. Ring set..... 1 No.
3. Power Cable..... 1 No.
4. External probe..... 1 No.
5. Stirr bar..... 1 No.

## SPECIFICATIONS

<b>PARAMETERS</b>	<b>OMC250</b>
Internal tank dimensions (D x H)	118 mm x 88 mm
Unit External Dimensions (W x D x H)	250 mm x 215 mm x 240 mm
Oil tank capacity	1000 ml
Mains voltage	220v - 240v
Power consumptions	300w
Temperature range	Ambient to 250°C
Tank material	SS 304
Display	7 Segment LED
Accuracy in temp.	±1°C upto 100°C and ±2°C above 100°C
Timer Display	Yes (Max upto 999min) & infinite
External probe	Yes (PT-100)
Error setting	Yes
PID settings	Yes
Probe error detection	Yes ( If any open circuit)
<b>Fuse rating</b>	2 Amps

## SPECIFICATIONS

<b>PARAMETERS</b>	<b>OMC010</b>
Internal tank dimensions (D x H)	182 mm x 142 mm
Unit External Dimensions (W x D x H)	247 mm x 270 mm x 300 mm
Oil tank capacity	3057 ml
Mains voltage	220v - 240v
Power consumptions	800w
Temperature range	Ambient to 250°C
Tank material	SS 304
Display	7 Segment LED
Accuracy in temp.	±1°C upto 100°C and ±2°C above 100°C
Timer Display	Yes (Max upto 999min) & infinite
External probe	Yes (PT-100)
Error setting	Yes
PID settings	Yes
Probe error detection	Yes ( If any open circuit)
Fuse rating	5 Amps

## SPECIFICATIONS

<b>PARAMETERS</b>	<b>OMS250</b>
Internal tank dimensions (D x H)	118 mm x 88 mm
Unit External Dimensions (W x D x H)	250 mm x 215 mm x 275 mm
Oil tank capacity	1000 ml
Mains voltage	220v - 240v
Power consumptions	300w
Speed control	PID and Digital energy regulator
Speed range	300-1500 RPM
Speed accuracy	+/-10 RPM
Speed feedback	Yes
Temperature range	Ambient to 250°C
Tank material	SS 304
Display	7 Segment LED
Accuracy in temp.	±1°C upto 100°C and ±2°C above 100°C
Timer Display	Yes (Max upto 999min) & infinite
External probe	Yes (PT-100)
Error setting	Yes
PID settings	Yes
Probe error detection	Yes ( If any open circuit)
Fuse rating	2 Amps

## SPECIFICATIONS

<b>PARAMETERS</b>	<b>OMS010</b>
Internal tank dimensions (D x H)	182 mm x 142 mm
Unit External Dimensions (W x D x H)	247 mm x 270 mm x 320 mm
Oil tank capacity	3057 ml
Mains voltage	220v - 240v
Power consumptions	800w
Speed control	PID and Digital energy regulator
Speed range	300-1500 RPM
Speed accuracy	+/-10 RPM
Speed feedback	Yes
Temperature range	Ambient to 250°C
Tank material	SS 304
Display	7 Segment LED
Accuracy in temp.	±1°C upto 100°C and ±2°C above 100°C
Timer Display	Yes (Max upto 999min) & infinite
External probe	Yes (PT-100)
Error setting	Yes
PID settings	Yes
Probe error detection	Yes ( If any open circuit)
Fuse rating	5 Amps

## SPECIFICATIONS

<b>PARAMETERS</b>	<b>OMS020</b>
Internal tank dimensions (D x H)	217 mm x 209 mm
Unit External Dimensions (W x D x H)	273 mm x 300 mm x 405 mm
Oil tank capacity	7725 ml
Mains voltage	220v - 240v
Power consumptions	1600w
Speed control	PID and Digital energy regulator
Speed range	300-1500 RPM
Speed accuracy	+/-10 RPM
Speed feedback	Yes
Temperature range	Ambient to 250°C
Tank material	SS 304
Display	7 Segment LED
Accuracy in temp.	±1°C upto 100°C and ±2°C above 100°C
Timer Display	Yes (Max upto 999min) & infinite
External probe	Yes (PT-100)
Error setting	Yes
PID settings	Yes
Probe error detection	Yes ( If any open circuit)
Fuse rating	7 Amps



## SAFETY AND WARNING



Important operating and maintenance instructions. Read the accompanying text carefully.



### Potential Electrical Hazards

- Only qualified persons should perform procedures associated with this Symbol.
- Equipment being maintained or serviced must be turned off prevent possible injury.

- When the **'AUTO RESUME'** feature is Enabled, the unit may start heating or operating on power supply.
- Ensure mains are switched off or unplugged when the product is not in use.



### CAUTION

- On long hours of usage the oil bath body surface will get hot.
- Do not operate the equipment unattended for long hours.
- The hot surfaces may cause burns to unprotected skin or to materials which may be damaged by elevated temperatures.
- The Cera wool emits fumes in the first few hours of operation ensure proper ventilation during first 15 minutes of usage.
- Always use proper protective equipment. (Clothing, gloves, goggles, etc.) Always follow good hygiene practices.
- Each individual is responsible for his / her own safety.

## SAFETY PRECAUTIONS

- Do not run the unit without oil.
- Do not keep unit on wet bench top.
- Always use safety goggles while working with oil bath.
- The unit should be plugged to standard 230V, 3 pin with proper earthing.
- Never use cracked or leaking glassware.
- Do not use empty flask in the oil bath, it may float and will not be levelled.
- Do not check the oil temperature by hand.



### WARNING

- Inadequate earthing at the installation facility can lead to hazardous electrical shocks.
- The manufacturer is not liable for any injury or death resulting from electrical hazards due to faulty earthing in the lab.

## PRODUCT IDENTIFICATION

- A. RING SET
- B. PERFORATED TRAY
- C. CONTROLLER UNIT
- D. POWER SOCKET
- E. DIN CONNECTOR
- F. POWER SWITCH
- G. RUBBER SHOES

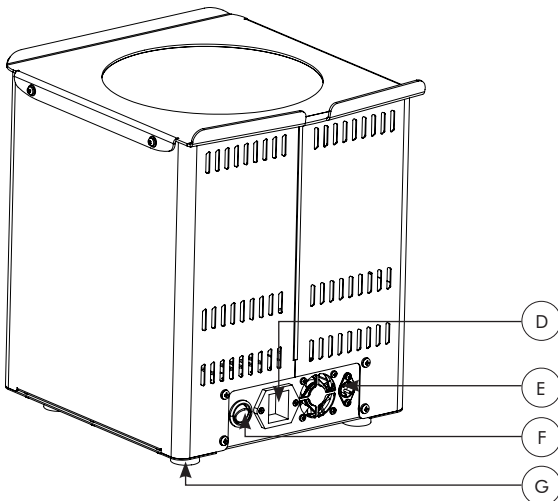
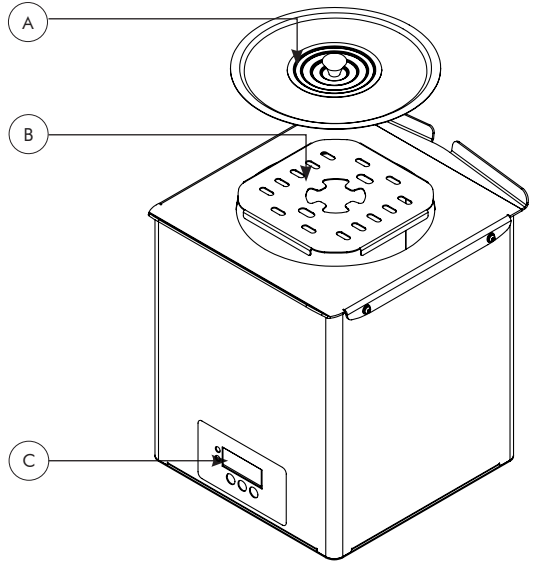

## INSTALLATION ON LAB BENCH

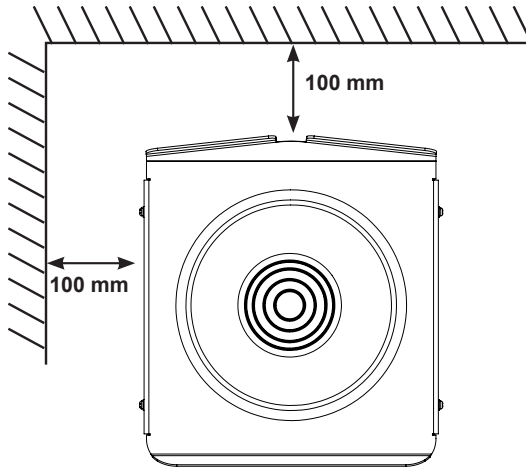

- Locate the unit on a level, stable surface near a grounded electrical outlet.
- The surface should be clean and free of dust and also ensure that there are no flammable substances present near the Unit .
- Allow sufficient clearance on all sides of the unit for proper ventilation.
- Make sure not to keep any items in front of cooling fan which is present behind the unit.
- With the power switch in the OFF position, plug the power cord into a grounded receptacle.
- Make sure that a minimum 100 mm gap is maintained between body and wall as shown in the above figure.
- Please ensure there is a fuse in the fuse holder.
- Connect the male end of the power cable to the wall socket.
- The unit is ready to operate for first usage.

## OPERATING THE OMS & OMC UNITS

- All operating controls are located on the front panel and back panel of the unit.
- The power switch, power socket and din connector are located on the back panel.
- Press the power switch, display will turn ON showing the current temperature of the unit by glowing the temperature indicator.
- Single press the set key and press up or down to set the parameters.
- One can press the upward key to increase temperature, speed or time and press the downward key to reduce the temperature, speed or time.
- If the external probe is not connected then the unit will show the oil temperature. In this mode the temperature range can be selected from ambient to 250°C.
- If the external probe is connected then the unit will show the probe temperature. In this mode the temperature range can be selected from ambient to 250°C.
- First set the desired temperature. Once this is confirmed single press the set key to get into the speed regulation in OMS and timer in OMC unit.
- Speed regulation in OMS will be 300-1500 RPM and time regulation will be from 1-999mins and infinite.
- Once the speed or the time is set then again single press the set key to start the process.
- If one press the upward or downward key in OMS when the process is ON then the speed increases or decreases directly based on pressing of the upward or downward key.
- If one press the upward or downward key in OMC during the process is ON then the set temperature increases or decreases directly based on pressing of the upward or downward key. To set the new temperature one has to single press the set key.

- If one wants to know the set temperature during the process then single press the set key.
- If one wants to interrupt the process in between then long press the set key until a beep sound occurs stating that the process is terminated.
- If the stir bar slips out in OMS then reduce the speed to zero so that the stir bar comes back to its rotating zone.
- If one wants to run the OMS unit only as a stirrer then one should set temperature below ambient and then set the speed to required RPM.
- In the OMC once the time is complete the unit will give a buzzer sound indicating the process is completed
- Once the parameter in the unit is set and the process is started then the unit will show the temperature and time or speed along with the respective indicator light in the default mode.
- Place the perforated tray inside the tank and then fill the oil upto desired level. Now place the conical flask on the perforated tray and fill the solution in it. To precisely control the solution inside the flask use the external probe
- Place the stirr bar inside the conical flask in case of stirring in OMS series.

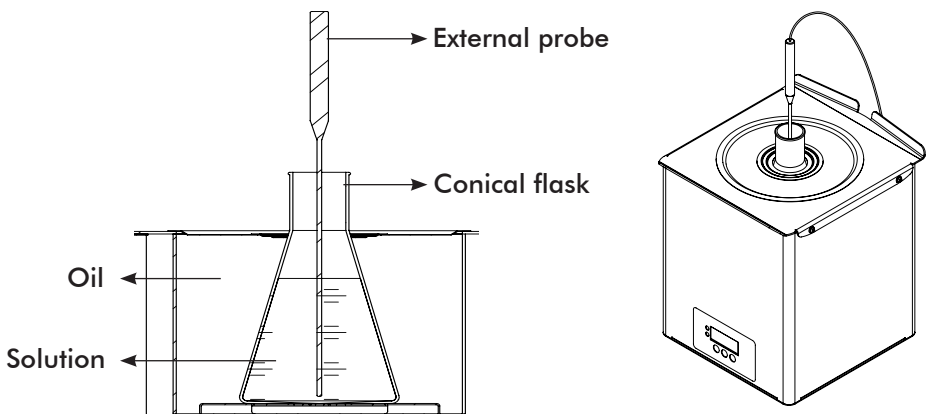

*Image shows controlling the temperature of the liquid by using external probe.*

## SETTING THE TEMPERATURE AND SPEED

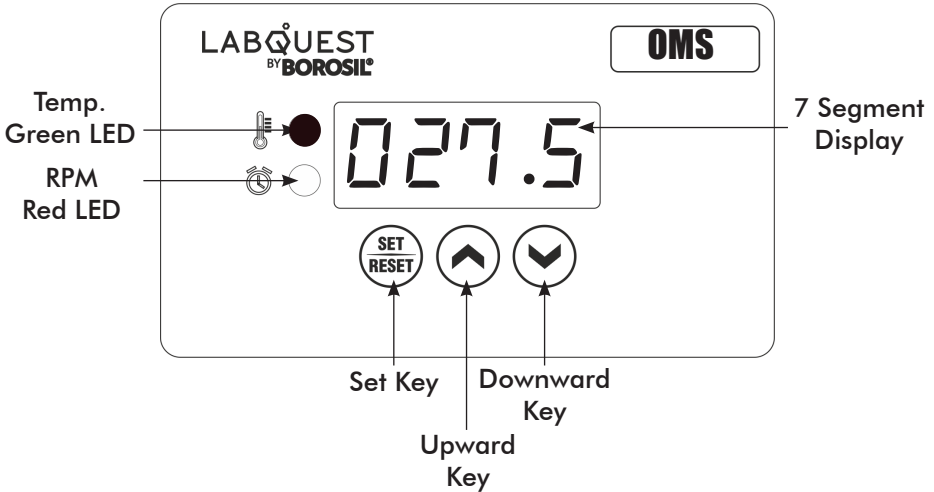

### 1. Set key

- **Upward key**
  - » To increment the set parameter value.
- **Downward key**
  - » To decrement the set parameter value.

### 2. Switch

- Single Press the set key : To select the particular parameter value.
- Long Press the set key : To reset the set parameter, to exit the process and to jump into the settings.

### 3. Green LED

- This indicates the set temperature and current temperature.

### 4. Red LED

- This indicates the set RPM value and current RPM value.

## SETTINGS OF OMS

Long press the selector knob upto 7 seconds to get into the settings of OMS when the unit is not in a process. First error setting will appear when this step is followed.



## TIME SETTINGS IN OMS IN TIME ENABLE MODE

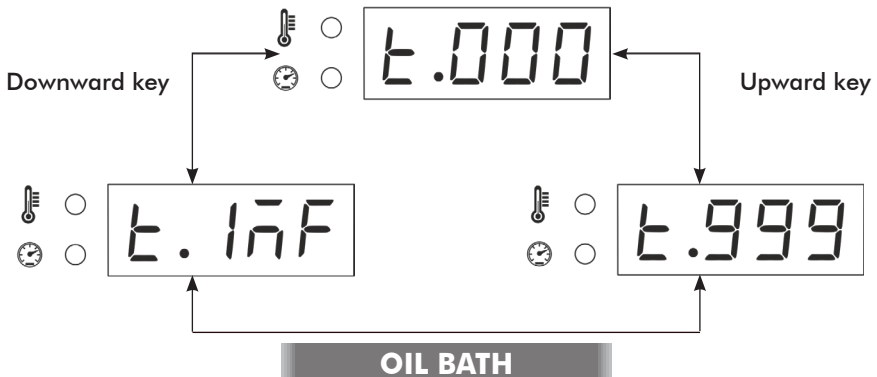

## WORKING OF OMS

### PROBE MODE

1. In the default power ON condition active probe indication message will be shortly shown.



2. If temperature of the oil tank greater than 50°C then 'HOT' message will appear frequently to prevent direct touch on the Oilbath.



3. Press the set key upward or downward to set the desired temperature, RPM and time.
4. To set parameter,
  - User can set temperature :
    - » Internal Probe: 0 to 250°C.
    - » External Probe: 0 to 250°C.

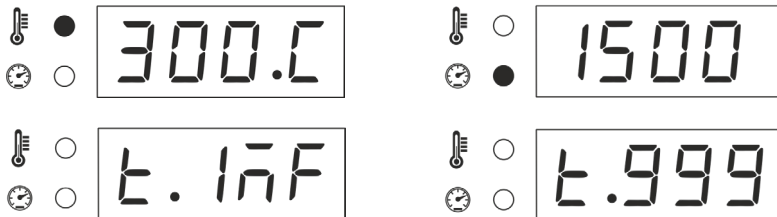

- User can set Min RPM 300 and Max RPM 1500.
- User can set the time 1 to 999 min and also can set the infinite time by pressing the downward key.
- Single press to change the set parameter from Temperature, RPM to Time and to start the process.

5. While in process, user can change the set RPM value.
6. Single press to check the set temperature value.
7. While in process, the user can STOP the process by long pressing the set key.



**NOTE:** In default mode, time setting will be disabled.

8. If time is enabled, then 3 windows will be displayed in the process (Temp, RPM, Time).
9. If time is disabled, then 2 windows will be displayed in the process (Temp, RPM).
10. If user set the time between 1 to 999 mins, then countdown time will be displayed in process and once the time is complete, the process will terminate automatically.
11. If user set the infinite time, then elapse time will be displayed and process will be continue until user terminates it.
12. Display alternately shows the process Temperature, RPM and Time.

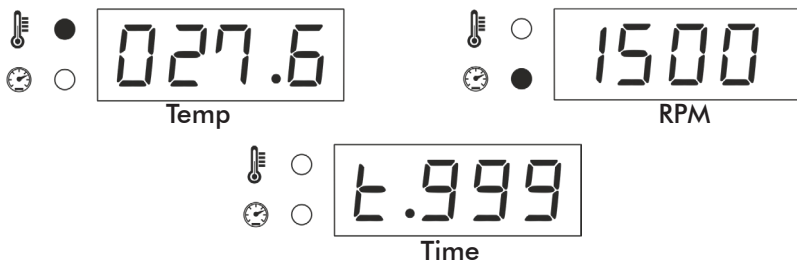

- The LED will blink green to indicate a set temperature.
- The LED will blink red to indicate a set rpm.
- GREEN LED indicates the process Temp.
- RED LED indicates the process RPM.
- Both LED will be OFF for time indication (min).

## ENERGY REGULATOR MODE

1. In the default power ON condition probe error message will be shortly shown.

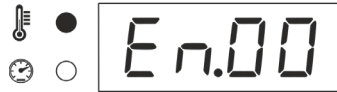

2. If temperature of oil tank greater than 50°C then 'HOT' message will appear frequently to prevent direct touch on the unit.



3. Press the set key upward and downward to set the desired energy, RPM and time.
4. To set parameter,
  - User can set energy regulator : 0 to 10.
  - User can set Min RPM 300 to Max RPM 1500.
  - User can set the time 1 to 999 min and also can set the infinite time by pressing upward key.

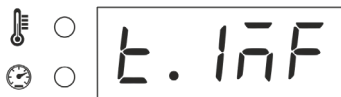
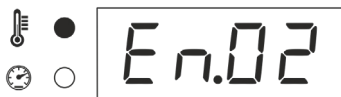

5. Single press to change the set parameter from Energy, RPM to Time and to start the process.
6. While in process, the user can change the set RPM value.

**NOTE:** In default mode, time setting will be disabled.

7. While in process, the user can STOP the process by long pressing the set key.
8. If time is enabled, then 3 windows will be displayed in the process (Energy, RPM, Time).
9. If time is disabled, then 2 windows will be displayed in the process (Energy, RPM).
10. If the user set the time between 1 to 999 mins, then countdown time will be display in process and once the time is complete process will terminate automatically.
11. If the user set the infinite time, then elapse time will be displayed and process will be continue until the user terminates it.
12. Display alternately shows the process Temperature, RPM and Time.
  - GREEN LED indicates the energy regulator.
  - RED LED indicates the process RPM.
  - Both LED will be OFF for time indication (min).

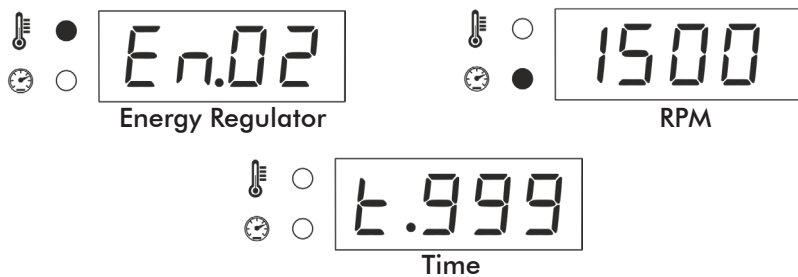

## SETTINGS OF OMC

Long press the selector knob upto 7 seconds to get into the settings of OMC when the unit is not in a process. First error setting will appear when this step is followed.



## TIME SETTINGS IN OMC

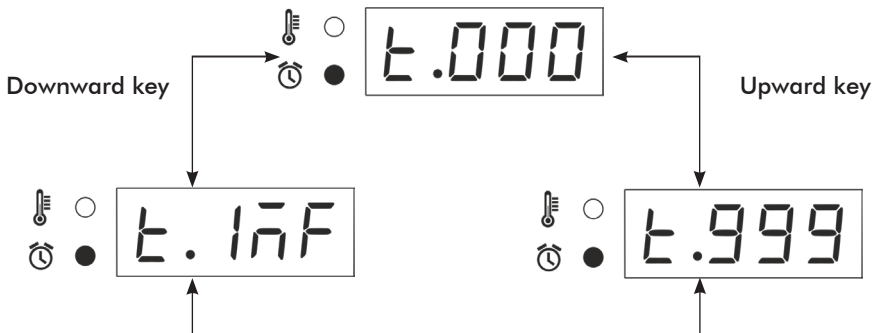

## WORKING OF OMC

### PROBE MODE

1. In the default power ON condition active probe indication message will be shortly shown.



2. If temperature of the oil tank greater than 50°C then 'HOT' message will appear frequently to prevent direct touch on the Oilbath.



3. Press the set key upward or downward to set the desired temperature and time.
4. In set parameter,
  - User can set temperature:
    - » Internal Probe: 0 to 250°C.
    - » External Probe: 0 to 250°C.

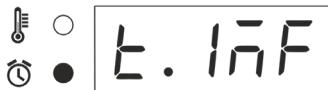
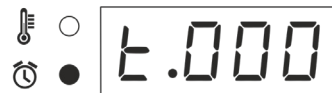

- User can set the time 1 to 999 min and also can set the infinite time by rotating knob anticlockwise.
- The LED will blink green to indicate a set temperature.
- The LED will blink red to indicate a set rpm.

5. Single press to change the set parameter from Temperature to time and to start the process.
6. While in the process, user can check or change the set temperature by single pressing and rotating the set key upward or downward.



7. While in process, the user can STOP the process by long pressing the set key.
8. In the process 2 windows will appear alternately displaying (Temperature, Time).
9. If user set the time between 1 to 999 mins, then countdown time will be displayed in the process and once the time is complete, process will terminate automatically.
10. If user set the infinite time, then elapse time will be displayed and process will be continue until the user terminates the it.
11. Display alternatelys show the process Temperature and Time.
  - GREEN LED indicates the process temp.
  - RED LED indicates the elapse time or countdown time.



## FEATURES OF OMS & OMC

- In default state, long press to exit and 7 seconds Long press to switch into the feature setting mode.
- Single press to select and save the changes.
- Press upward and downward to change the settings.

### 1. Error Setting Mode

- This mode is used to set the one point error called one point calibration.
- Error can be set upto -20 to +20 °C.
- If external probe will be connected then error will be set for an external probe otherwise error will be set for an internal probe.

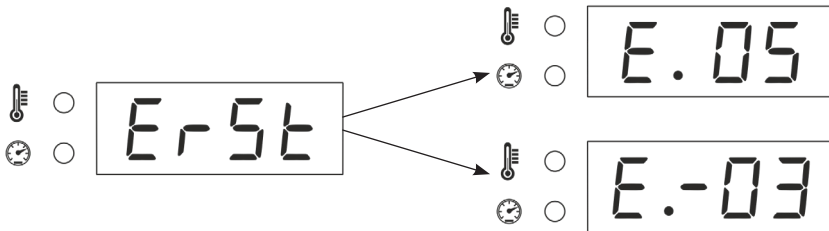

### 2. Heat Mode

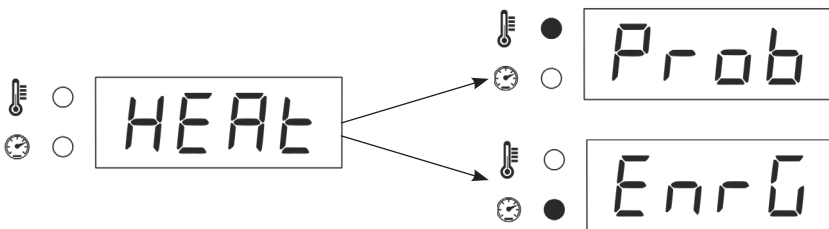

- » In **probe**, temperature is precisely controlled by PID controller.
- » By default, the internal probe is connected to control the top plate temperature.
- » User can precisely control the temperature of the particular media (Ex. water, oil) by external probe.

- » **Energy regulator** value can set between 0 to 10.
- » In this mode, top plate temperature is controlled by different duty cycle values.
- » Depending upon the value of energy regulator, heating can be slow or fast.

### 3. Speed Mode (**Applicable in case of OMS only**)

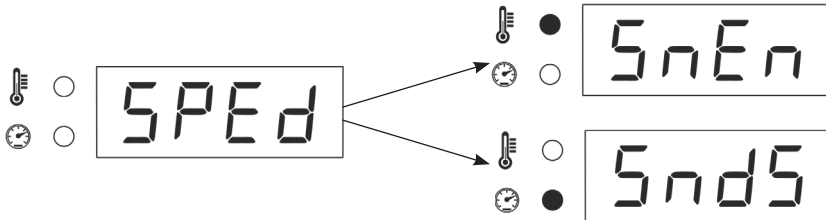

- » In **speed control mode**, user can enable and disable the setting.
- » By default, setting is enable.
- » **Enable** : To precisely control the speed using sensor feedback.
- » **Disable** : To independently control motor speed.

### 4. Safe Mode

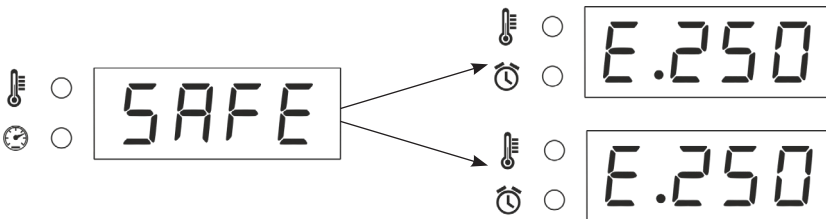

- In this mode, user can lock the internal and external probe maximum set temperature value.
- **Internal Probe** : User can lock the set temperature value anywhere in between ambient to 150°C.
- **External Probe** : User can lock the set temperature value anywhere in between ambient to 150°C.

- Example : If the user locks internal set temperature value to 200°C using the safe function and saves it, then user can only set internal probe temperature value upto on 200°C.

## 5. Slope Mode

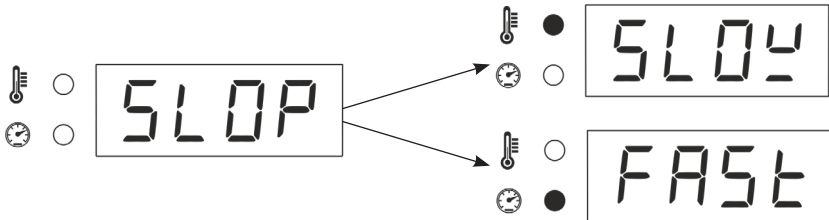

- In this mode, user can set slow or fast heating.
- **Slow** : Heating will be slow and there will be less chances of temperature overshooting.
- **Fast** : Heating will be fast but the chances of temperature overshooting will be more.

## 6. Timer Mode

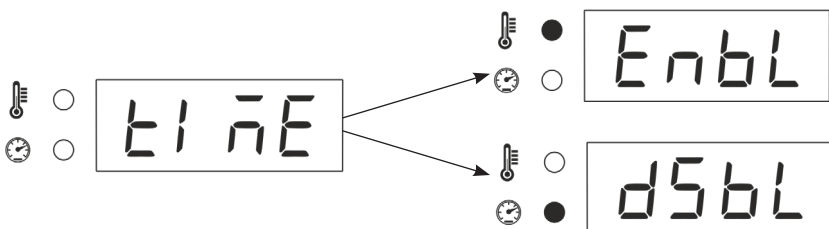

- In this mode, user can set time based heating.
- **Enable** : User needs to set time before starting the process.
- **Disable** : User isn't required to set time before starting the process.

## 7. Auto Resume Mode

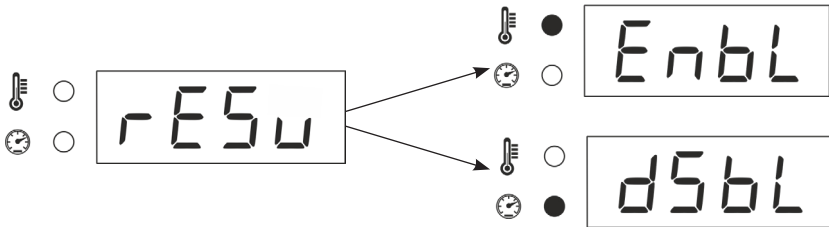

- In this mode, the user can set auto resume when power goes off it will automatically start the process upto the set values.
- **Enable** : User needs to set auto resume to start the process.
- **Disable** : User needs to disable auto resume for not to start the process.

- When the '**AUTO RESUME**' feature is Enabled, the unit may start heating or operating on power supply.
- Ensure mains are switched off or unplugged when the product is not in use.

## Alert Notifications

- If **Internal probe** is active or at the time of probe change following message will be displayed shortly.



- If **External probe** is active or at the time of probe change following message will be displayed shortly.

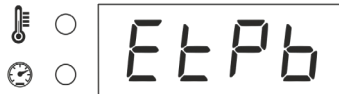

- If temperature of top plate is greater than 50°C then 'HOT' message will appear frequently to prevent direct touch on the hot plate.



## Error

- If Probe is disconnected or at the probe failure following message will be display shortly.

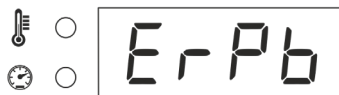

- **Corrective Method** : If this error message shown then user should check probe is properly connected or probe needs to change. Until user can change setting to energy regulator mode for heating.

## ACCESSORIES

### STIR BAR (Only for OMS series)

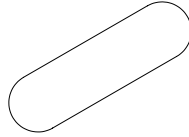

(8 DIA X 25 LENGTH)

### EXTERNAL PROBE (PT HUNDRED)

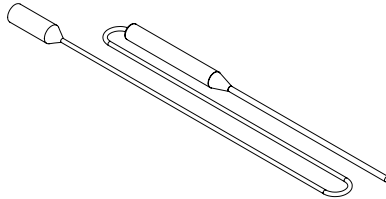

(TEMPERATURE RANGE AMBIENT TO 260°C)

### SS RING SET

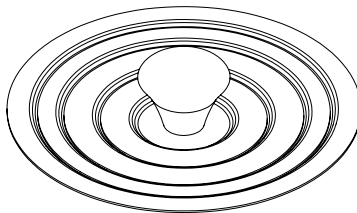

## TROUBLESHOOTING

### 1. The unit is not turning ON.

- Check the power supply in AC mains.
- Make sure power cable is inserted to the socket properly.
- Check whether the main switch is ON or OFF.
- Check if the red illuminated switch is OFF.
- Ensure the main switch is ON.
- Check if the unit is heating and the switch is not illuminating, the switch needs to replace.
- If the unit is not heating, please check the fuse.

### 2. If the fuse is blown.

- Switch OFF the unit and remove power cable from AC mains.
- Open the fuse tray present in the power socket.
- Remove the glass tube fuse.
- Check if the fuse is blown.
- If the fuse is blown, replace it with a respective glass tube fuse that is provided in the product specification .

### 3. No or low heating

- Ensure the unit is ON.
- Ensure the temperature controller is not set at zero or set near to ambient temperature
- If the heating power is lower than previous noticed value for temperature controller, it may be damaged.
- If the problem persists, please contact Borosil Service Center.





## WARRANTY REGISTRATION

Please handover this registration form to the distributor from where you have purchased this product. The warranty is valid only when this warranty registration form is received by us within 30 days from the date of purchase.

Product: OIL BATH SERIES

Product Sr. No.: \_\_\_\_\_

Date of Invoice : \_\_\_\_\_

Invoice No.: \_\_\_\_\_

### Customer name & address

Name : \_\_\_\_\_

\_\_\_\_\_

Address: \_\_\_\_\_

\_\_\_\_\_

\_\_\_\_\_

Telephone: \_\_\_\_\_

E-mail: \_\_\_\_\_

### Customer sign & seal

### Dealer name & address

Name : \_\_\_\_\_

\_\_\_\_\_

Address: \_\_\_\_\_

\_\_\_\_\_

\_\_\_\_\_

Telephone: \_\_\_\_\_

E-mail: \_\_\_\_\_

### Dealer sign & seal

# BOROSIL® Scientific

STATEMENT OF WARRANTY

Borosil confirms that this product has been manufactured in accordance with our technical specifications and quality requirements.

- Borosil warrants the product from manufacturing and workmanship defects for a period of 12 months from the date of invoice.
- Warranty is void, if apparatus is not operated as prescribed in the operating manual supplied along with the unit.
- To be covered under warranty.
  - » Units have to be connected to standard 230V, 50Hz, 3A wall sockets with proper earthing for Oil bath series.
  - » The units should never be run with heater on continuously for more than 5 hours.
  - » Corrosion damage to the tank due to spillage of chemical will not be covered under warranty.
  - » Warranty does not cover replacement of heating element more than once.
  - » Warranty does not cover rust and physical damage to metal parts due to corrosive environment in the lab.

**Terms:**

- » In the event of malfunction due to defect, the buyer will have to follow the Borosil’s service process.
- » Certain units can not be serviced/rectified at the buyer’s place and the units may have to be brought to Borosil’s service center as advised by Borosil’s representatives.
- » In no event shall Borosil be liable for consequential or incidental damages.

<b>INVOICE DATE</b>	<b>BUYER</b>	<b>AFFIX SERIAL NUMBER</b>
<b>INVOICE#</b>		
<b>Dealer name &amp; address</b>		<b>Dealer sign &amp; seal</b>

**BOROSIL SCIENTIFIC LIMITED**

Corporate Office : 1101, Crescenzo G-Block, Opp. MCA Club, Bandra Kurla Complex, Bandra (E), Mumbai-400051, India.



**: MANUFACTURED BY :**

**Borosil Scientific Limited**

Plot No.7, Sr. No. 234, 235 & 245,  
Indialand Global Industrial Park,  
Hinjewadi Phase 1, Pune - 411057

*Write to us on above address.*

**: MARKETED BY :**

**Borosil Scientific Limited**

1101, G-Block, Parinee Crescenzo,  
BKC, Bandra East, Mumbai - 51

Maharashtra, India

**: CUSTOMER CARE CONTACT :**

**Phone : 1800 22 4551 | Email : [lab.support@borosil.com](mailto:lab.support@borosil.com)**

**Website : [www.borosilscientific.com](http://www.borosilscientific.com)**