

LABQUEST
BY **BOROSIL®**

MULTI POSITION HEATING MANTLE WITH CONTROLLER

OPERATING MANUAL

MPM062

MPM065

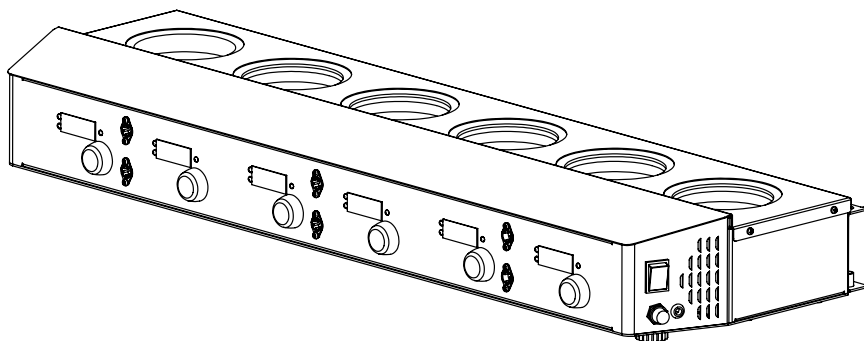

DEALER :

THANK YOU NOTE

We Borosil, one of India's most customer oriented brands truly appreciate your business and express our gratitude for the trust you have placed on us.

We hope your choice serves you well in your scientific endeavors and aspire to have the pleasure of doing business with you for years to come.

TABLE OF CONTENTS

Sr. No.	Particular	Page No.
1.	Packing list	6
2.	Product Specifications	7
3.	Safety and Warning	8
4.	Product Identification	10
5.	Product Installation	11
6.	Operating Instructions	12
7.	Description of knob and LED	13
8.	Settings of MPM	14
9.	Working of MPM	15
10.	Features of MPM	20
11.	Troubleshooting	23
12.	Contact Information	28

PACKING LIST

1. MPM unit.....1 No.
2. Retort stand.....6 Nos.
3. Retort stand adapter.....6 Nos.
4. External Probe.....6 Nos.

PRODUCT SPECIFICATION

PARAMETERS	MPM062	MPM065
No. of position	6	6
Temperature Range	Ambient to 400°C	Ambient to 400°C
Temperature Accuracy	±1°C upto 100°C, ±2°C upto 200°C and ±3°C above 200°C.	±1°C upto 100°C, ±2°C upto 200°C and ±3°C above 200°C.
Process Timer	0-999 min and infinite time	0-999 min and infinite time
Temperature control	PID Control and digital energy regulator	PID Control and digital energy regulator
Max flask capacity	250 ml	500 ml
External probe	PT100	PT100
Unit External Dimensions	1000X330X135mm	1000X330X135mm
Power consumptions	900 W	1200 W
Display timer	0-999 min and infinite	0-999 min and infinite

**CAUTION**

Always use proper protective equipment. (Clothing, gloves, etc.)

Always follow good hygiene practices.

Each individual is responsible for his / her own safety.

Always wear shatter proof eye protection.

SAFETY AND WARNING

Important operating and maintenance instructions. Read the accompanying text carefully.

**Potential electrical hazards**

Only qualified persons should perform procedures associated with this Symbol.

Equipment being maintained or serviced must be turned off to prevent possible injury.

Inadequate earthing at the installation facility can lead to hazardous electrical shocks. The manufacturer is not liable for any injury or death resulting from electrical hazards due to faulty earthing in the lab.

**Potential heat hazards**

Only qualified persons should perform procedures associated with this Symbol.

Do not touch the MPM unit directly when the unit is in hot condition.

SAFETY PRECAUTIONS

The following precautions should be taken when operating or working near the MPM065 & MPM065:

- Do not use the product if there is any electrical or mechanical damage.
- Repair should be performed only by qualified individuals.
- Do not use accessories which are not recommended by the manufacturer as it may affect the performance.
- Do not use the unit in hazardous atmosphere or with hazardous material for which the unit is not designed.
- Always use the unit on a level & stable surface for best performance and maximum safety.
- The instrument is designed to be used in the laboratory environment.
- Clean the unit with a damp cloth using a mild detergent only. Do not use chemical cleaning agents.
- If liquid is spilled on the unit, first disconnect the unit from the external (main) power supply and then clean the unit with damp cloth.

PRODUCT IDENTIFICATION OF MPM

- A. TOP PLATE
- B. HEATER COIL
- C. CONTROL PANEL
- D. SELECTOR KNOB
- E. DIN CONNECTOR
- F. SWITCH
- G. FUSE HOLDER
- H. RETORT STAND ADAPTER
- I. RUBBER SHOE

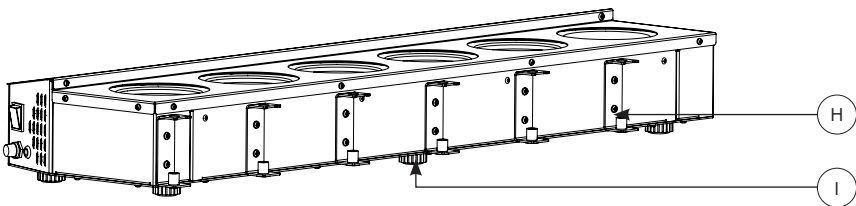
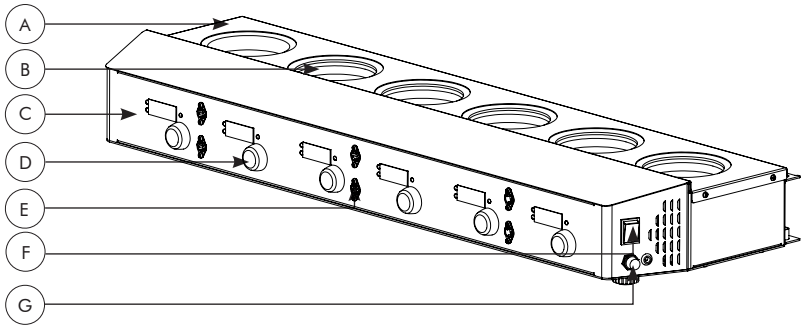

PRODUCT INSTALLATION

- Locate the unit on a level, stable surface near a grounded electrical outlet.
- The surface should be clean, free of dust and moisture.
- Ensure that there are no flammable substances present near the unit .
- Allow sufficient clearance on all sides of the unit for proper ventilation.
- With the power switch in the OFF position, plug the power cord into a grounded receptacle.
- Make sure that a minimum 100 mm gap is maintained between the unit, wall and also with other instruments present in the lab as shown in the figure below.
- Connect the male end of the power cable to the wall socket.
- The unit is ready to operate for first usage.

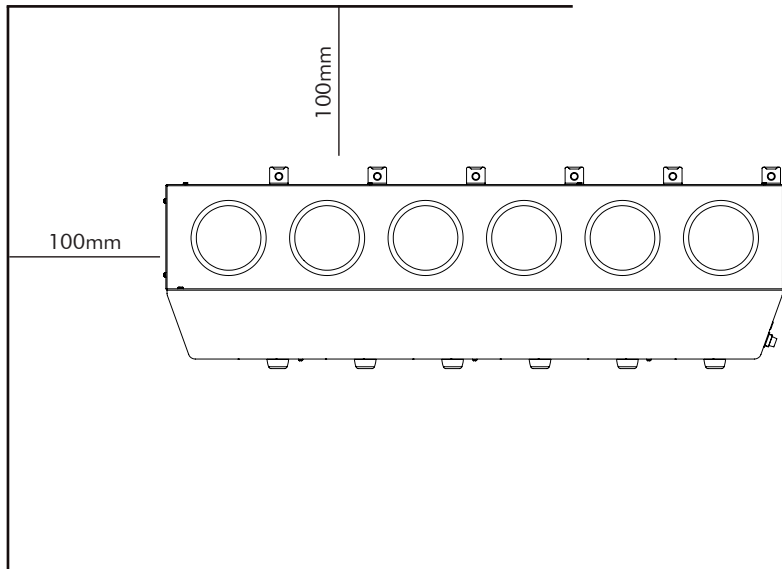

OPERATING INSTRUCTIONS

- All operating controls are located on the front panel of the unit.
- Connect the External probe to the respective din connector which is located at the front panel.
- Press the main switch, display will turn ON showing the current temperature of the unit.
- Single press or rotate the selector knob to set the parameters.
- One can rotate the selector knob in clockwise to increase temperature or time and can rotate in anticlockwise to reduce the temperature or time.
- If the external probe is not connected then the unit will get into the energy regulator mode. In the energy regulator mode user can set the energy regulator value from 0 to 10.
- If probe is connected, first set the desired temperature in which the unit should be run. The unit is having the temperature range from ambient to 400°C. Once this is confirmed single press or rotate the selector knob to get into the timer mode which is having the range from 1-999 min and infinite time.
- Once the desired temperature and the time is set then again single press the selector knob to start the process.
- To change set temperature and time in between the process, single press the selector knob and it allow to change the parameters.
- If one wants to interrupt the process in between then long press the selector knob until a beep sound occurs stating that the process is terminated.
- Once the parameter in the unit is set and the process is started then the unit will display the temperature and time window along with the respective indicator light.
- Once the time is complete the unit will give a buzzer sound indicating the process is completed. The unit will switch OFF heating automatically and display current temperature.

DESCRIPTION FOR KNOB AND LED FOR MPM

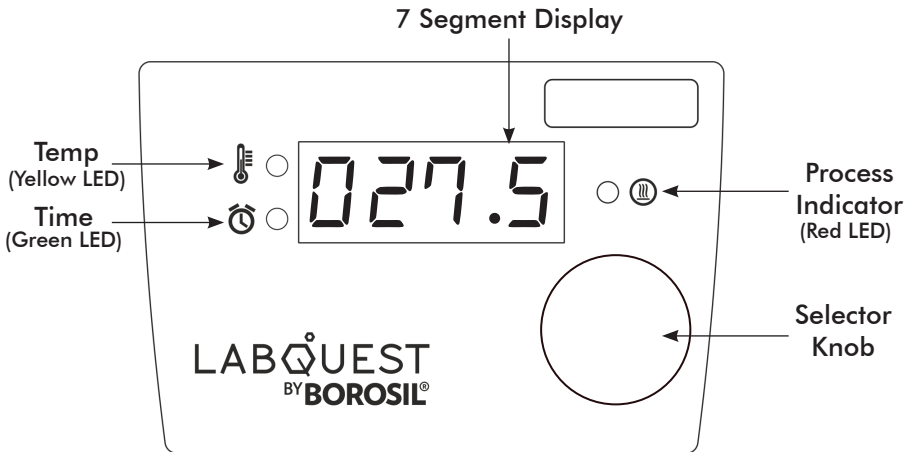

1. Selector Knob

- **Clockwise Rotation**

- » To increment the set parameter value.

- **Anti Clockwise Rotation**

- » To decrement the set parameter value.

2. Switch

- **Single Press** : To select the particular parameter value.

- **Long Press**: To reset the set parameter, to exit the process and to jump into the settings.

3. Yellow LED

- This indicates the set temperature and process temperature.

4. Green LED

- This indicates the set time and process time.

5. Red LED

- This indicates the process status.

SETTINGS OF MPM

Long press the selector knob to get into the settings of MPM when the unit is not in a process. Rotate the knob to change the mode and single press to set and save the mode settings. First Safe temperature setting will appear when this step is followed.

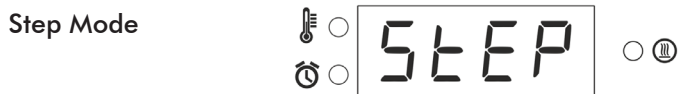

TIME SETTINGS IN MPM

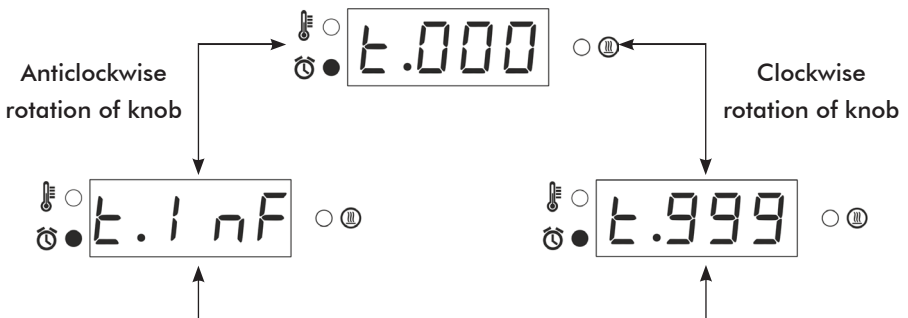

WORKING OF MPM

PROBE MODE

1. In default power ON condition external probe indication message will be shortly shown and current temperature will be shown as follow.



2. Rotate the knob clockwise or anticlockwise to set the desired temperature and time.
3. In temperature parameter,
 - User can set upto temperature of 400°C.
 - While setting the temperature parameter, yellow LED is ON.



4. Single click to change the set parameter from Temperature to time.
5. User can set the time from 1 to 999 minutes and also can set the infinite time by rotating knob anticlockwise. While setting the time parameter, green LED is ON.



6. Single click to start the process.
7. Red LED indicates process ON.

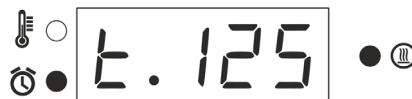

8. While in process, user can check or change the set temperature by single pressing and rotating the selector knob clockwise or anticlockwise. At that time yellow LED will blinks continuously.



9. After setting the temperature, user can check or change the set time by single pressing and rotating the selector knob clockwise or anticlockwise. At that time green LED will blinks continuously.



10. While in process, user can STOP the process by long pressing the selector knob.
11. In process, the display will be alternately show temp and time.
12. If step is 1, user can select soak time or total time. In soak time, timer starts after process temperature reached to set temperature and time.
13. If user set the time between 1 to 999 mins, then countdown time will be displayed in process and once the time is complete process will terminate automatically.
14. If user set the infinite time, then elapse time will be displayed upto 999mins and process will be continue until user terminates it.
15. Display will alternately show the process temperature and time.
- YELLOW LED indicates the process temp.
 - GREEN LED indicates the elapse time or countdown time.

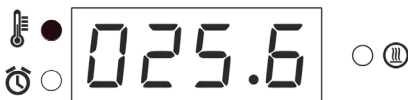

Temp



Time

ENERGY REGULATOR MODE

1. In default power ON condition and if probe is not connected probe error message will be shortly shown and default following message will show.



2. Rotate the knob clockwise and anticlockwise to set the desired energy regulator value.
3. In set parameter,
 - User can set energy regulator : 0 to 10.

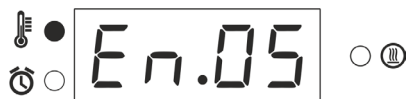

- User can set the time 1 to 999 minutes and also can set the infinite time by rotating knob anticlockwise.

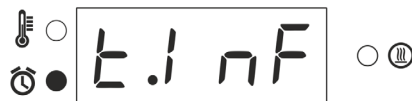

4. Single click to change from energy regulator value to time and to start the process.
5. Red LED indicates process ON.

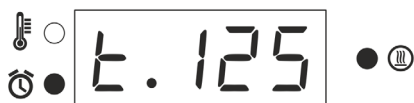

6. While in process, user can check or change the energy regulator value by single pressing and rotating the selector knob clockwise or anticlockwise. At that time yellow LED will blink continuously.

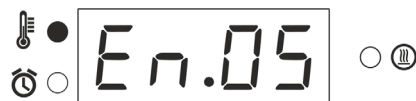

7. After setting the temperature, user can check or change the set time by single pressing and rotating the selector knob clockwise or anticlockwise. At that time green LED will blink continuously.



8. While in process, user can STOP the process by long pressing the selector knob.
9. In process 2 windows will be alternately appear in the display (energy regulator value and time).
10. If user set the time between 1 to 999 mins, then countdown time will be display in process and once the time is complete process will terminate automatically.
11. If user set the infinite time, then elapse time will be displayed upto 999mins and process will be continue until user terminates it.
12. Display will alternately show the energy regulator value and time.
- YELLOW LED indicates the process temperature.
 - GREEN LED indicates the elapsed time or countdown time.



Energy regulator



Time

RESPONSE GRAPH OF MPM IN ENERGY REGULATOR MODE

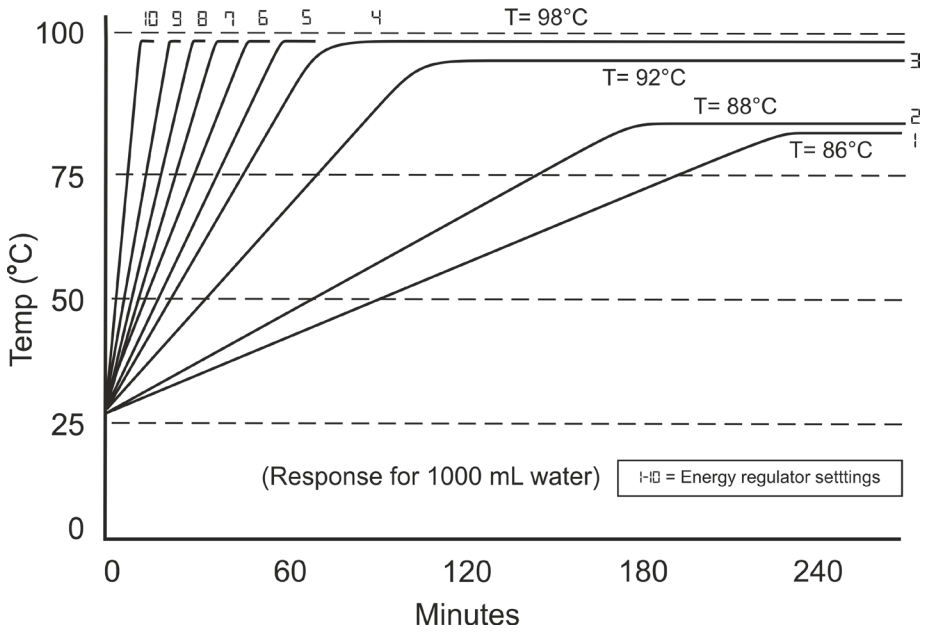

FEATURES OF MPM

- In default state, long press the selector knob to get into the feature setting mode and again long press to exit.
- Single click to select and save the changes.
- Rotate clockwise and anticlockwise to change the settings.

1. Safe Mode



- In PID mode, user can select safe mode.
- In this mode, user can lock the maximum set temperature anywhere between ambient to maximum value of 400°C.
- Example : If the user locks internal set temperature value to 300°C using the safe function and saves it, then user can only set external probe temperature value upto on 300°C.

2. Error Setting Mode

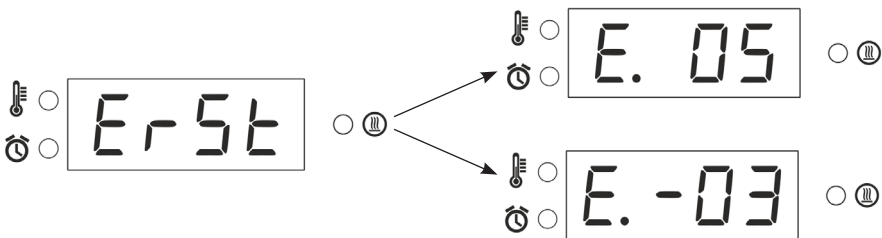

- In PID mode, user can select safe mode.
- This mode is used to set the one point error called one point calibration.
- Error can be set upto -25 to +25 °C.

3. Step Mode



- In PID mode and energy regulator mode, user can select safe mode.
- In this mode, user can set different temperature or different energy regulator value for different time.
- In this mode, user can set ramps upto 4.
- When user don't want ramp, select step 1.

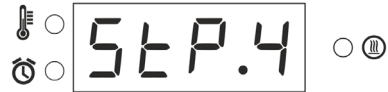
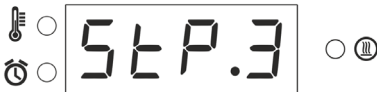
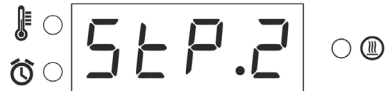

4. Time Mode

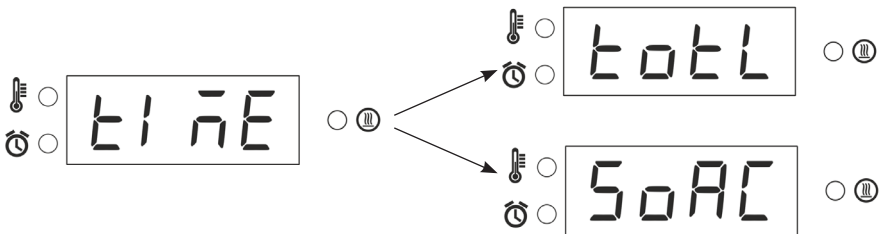

- In PID mode, user can select safe mode.
- In this mode, user can select when timer starts.
- **Total Mode:** In total time mode, timer will starts when process starts.
- **Soak Mode:** In Soak time mode, timer will only starts when process temperature reaches set temperature.

Alert Notifications

- If external probe is connected, it will display following message shortly and goes into PID mode.



- If probe is disconnected, energy regulator mode will be active. It will display following message shortly and goes into energy regulator mode.



Error

1. Coil Error

- If heater coil is disconnected or broken coil error following message will be displayed continuously.



Corrective Method: If this error message shown please replace the coil. If the problem persists, please contact Borosil Service Center.

2. Spill Error

- If liquid spills on the heater coil following message will be displayed and heater supply will shut OFF.



Corrective Method: If this error message shown then user should switch OFF the unit and let the heater dry naturally. Once heater dry completely, switch ON the unit and unit is ready to use it again.

TROUBLESHOOTING

1. The unit is not turning ON.
 - Check the power supply in AC mains.
 - Check whether the main switch is ON or OFF.
2. The unit is not turning ON.
 - Ensure the unit is ON and energy regulator mode is selected.
 - Ensure the unit is ON and the temperature controller is not set at zero.
 - If the heating power is lower than previously noticed value for the energy regulator, the heater coil may be damaged.
 - Replace the heating coil as directed.
 - If the problem persists, please contact Borosil Service Center.



Customer name & address

Name : _____

Address: _____

Telephone: _____

E-mail: _____

Customer sign & seal

Dealer name & address

Name : _____

Address: _____

Telephone: _____

E-mail: _____

Dealer sign & seal

LABQUEST BY BOROSIL®

Terms of service:

- In the event of malfunction due to defect, the buyer will have to follow the Borosil's service process.
- Certain units cannot be serviced/rectified at the buyer's place and the units may have to be brought to Borosil's service center as advised by Borosil's representatives.
- In no event shall Borosil be liable for consequential or incidental damages.

INVOICE DATE	BUYER	AFFIX SERIAL NUMBER
INVOICE#		
Dealer name & address		Dealer sign & seal

: MANUFACTURED BY :

Borosil Scientific Limited

Plot No.7, Sr. No. 234, 235 & 245,
Indialand Global Industrial Park,
Hinjewadi Phase 1, Pune - 411057

Write to us on above address.

: MARKETING BY :

Borosil Scientific Limited

1101, G-Block, Parinee Crescenzo,
BKC, Bandra East, Mumbai - 51

Maharashtra, India

: CUSTOMER CARE CONTACT :

Phone : 1800 22 4551 | Email : lab.support@borosil.com

Website : www.borosilscientific.com