

LABQUEST
BY **BOROSIL®**

MAGNETIC STIRRER

OPERATING MANUAL
MLS010

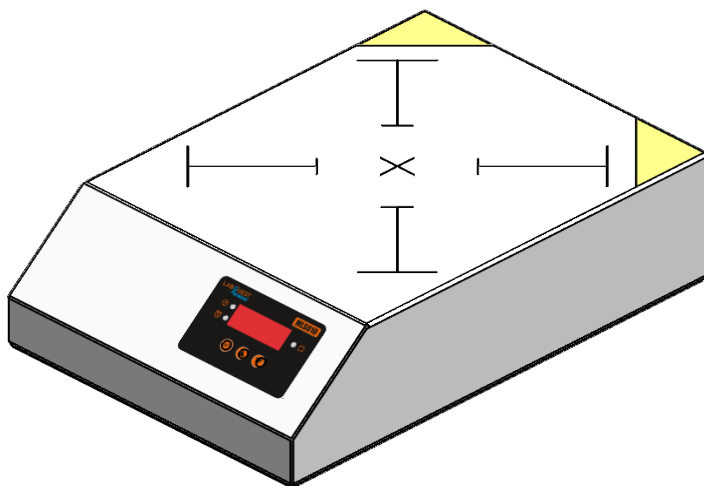

DEALER :

THANK YOU NOTE

We Borosil, one of India's most customer oriented brands truly appreciate your business and express our gratitude for the trust you have placed on us.

We hope your choice serves you well in your scientific endeavors and aspire to have the pleasure of doing business with you for years to come.

TABLE OF CONTENTS

Sr. No.	Particular	Page No.
1.	Packing List.....	7
2.	Product Specifications.....	8
3.	Safety and Warning.....	9
4.	Unboxing of The Product.....	10
5.	Product Installation.....	11
6.	Product Identification.....	12
7.	Description of Buttons & Functions.....	13
8.	Operations.....	14
9.	Features.....	15
10.	Troubleshooting.....	17
11.	Warranty Registration.....	19
12.	Statement of Warranty.....	21
13.	Contact Information.....	24

PACKING LIST

1. MLS010.....01No.
2. 24V Adapter.....01No.
3. MLS Manual.....01No.

PRODUCT SPECIFICATIONS

PARAMETERS	MLS010
SAP code	BLFHMLS01000000000
SAP Description	Magnetic low cost stirrer
No of stirring positions	1
Stirring Quantity(H ₂ O)	Upto 10L
Motor Type	BLDC
Stirring bar length	60 mm
Material Housing	Flat, sturdy stainless steel
Display	Digital LED (4 Digit 7 Segment Display)
Speed range	100-1000 rpm
Speed error	± 1% rpm
Timer	999 mins along with infinite time
Set-up plate dimensions	260 x 260 mm
Dimensions (W x D x H)	250 x 366 x 120 mm
Weight of the product	5.5 kg
Weight / load (it can sustain)	No direct loading above 20 kg
Ramp rate	0 - 2
Slip Detect	YES
Permissible ambient temperature	10°C to 45°C
Power input	AC 200 - 240 V, 50 Hz
Max current	1A
Power consumption	24W
Mains voltage	200V - 240V AC
Accuracy in temperature	Not Applicable
Error setting	Not Applicable
Warranty	1 yr

SAFETY AND WARNING



Important operating and maintenance instructions

Read the accompanying text carefully.



Potential electrical hazards

Only qualified persons should perform procedures associated with this symbol.



Lifting hazard warning

Take adequate safety measures when moving this device.

Equipment being maintained or serviced must be turned off and locked to prevent possible injury.



CAUTION

- Always use proper protective equipments. (Clothing, gloves, goggles, etc.)
- Always follow good hygiene practices.
- Each individual is responsible for his / her own safety.
- Do not keep the unit on wet bench top or work areas.
- Do not wash the unit with water.
- Wipe the unit with dry cloth after usage.
- In case of fluid spillage on the equipment, wipe it with dry cloth.
- The unit should be plugged to standard AC 230V 50Hz, 5A, 3 pin power cord.
- The unit should be plugged into power socket having proper earthing.



WARNING

Inadequate earthing at the installation facility can lead to hazardous electrical shocks. The manufacturer is not liable for any injury or death resulting from electrical hazards due to faulty earthing in the lab.

UNBOXING OF THE PRODUCT

UNPACKAGING INSTRUCTION

1. Remove the unit from the box.
2. Remove the adapter.

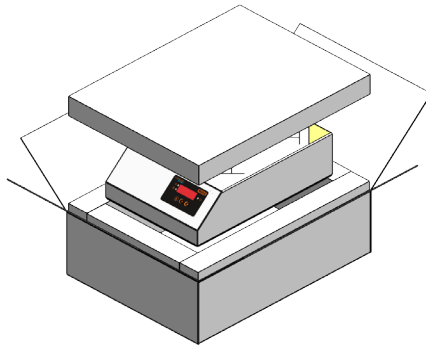

INSTALLATION OF UNIT

1. Plug the adapter to the unit & connect it to the wall socket of standard AC 230V 50Hz, 5 A.
2. Place the whole unit at the 100 mm gap from side and from back on clean and dry place.

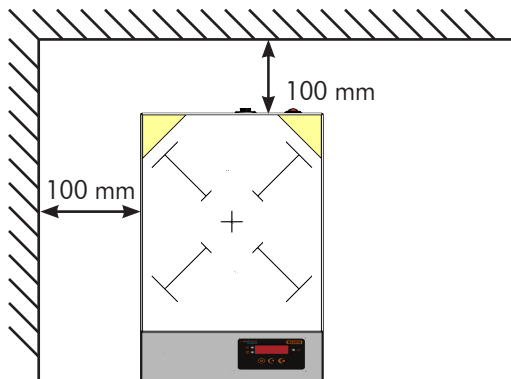

PRODUCT INSTALLATION

Direct load installation (Max load 20 kg)

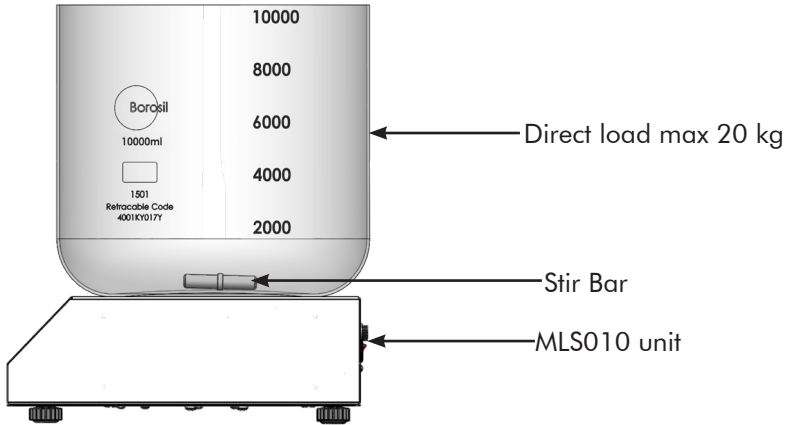

- * During direct load max limit is 20 kg on the MLS010.
- * Do not keep more than 20 kg load directly on MLS010.

Stir Bar specification

- Dumbbell stir bar should be used in bottle stirring.
- Pivot stir bar should be used for flat tumbler stirring.

PRODUCT IDENTIFICATION

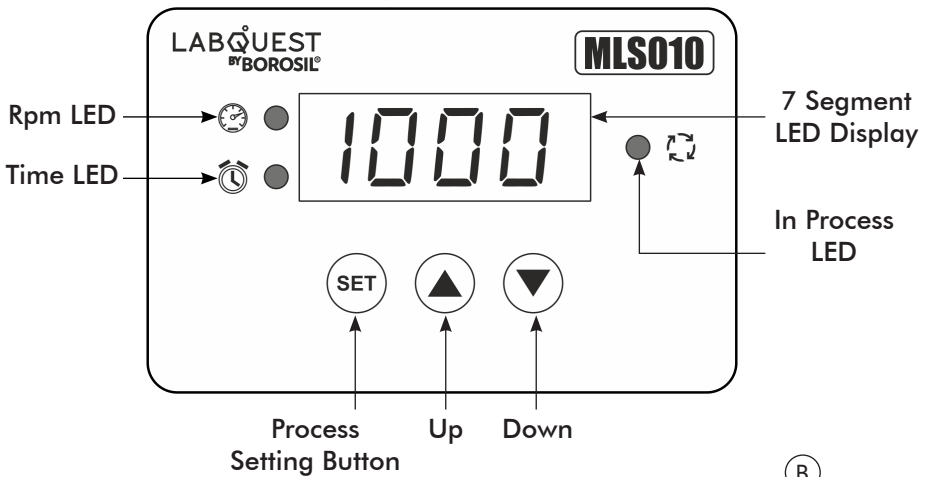
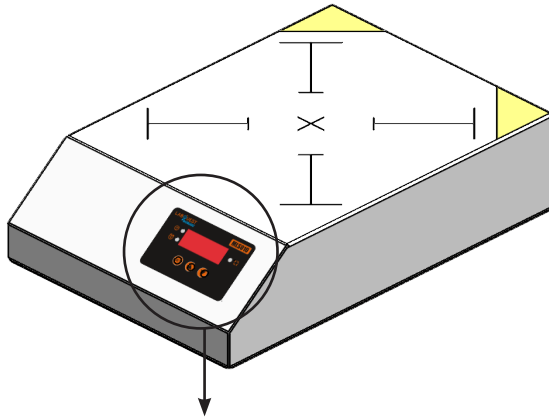

- A. POWER SWITCH
- B. 24V CONNECTOR
- C. PROGRAMMING PLUG

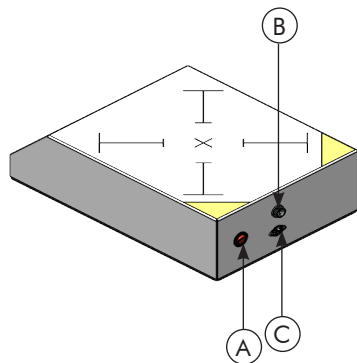

DESCRIPTION OF BUTTONS & FUNCTIONS

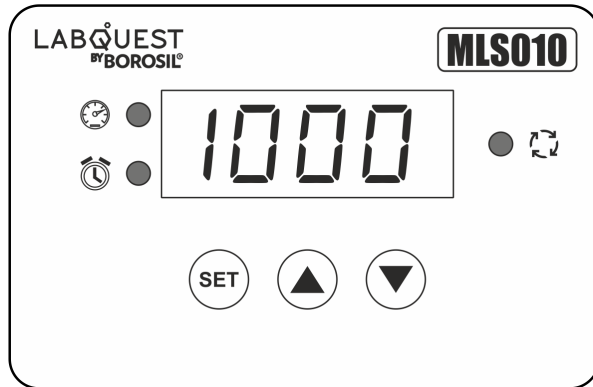

1. SET :

- Long Press SET Button on Home Screen - It is used to enter into the setting mode.
- Single Press SET Button - It is used to select the parameter which needs to be set and also to start the process.
- Long Press SET Button - It is used to exit from the process.

2. UP (▲) :

- It is used to increase the set parameters.

3. DOWN (▼) :

- It is used to decrease the set parameters.

OPERATIONS

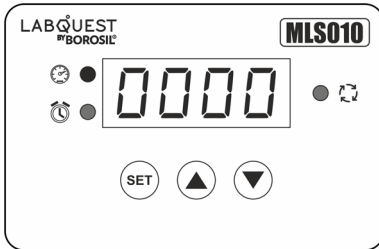

DEFAULT POWER ON STATE

- In default power ON state .
- The speed indicator will be illuminated by showing Rpm as 0.

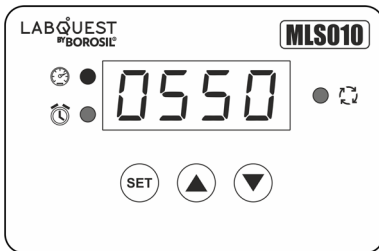

SETTING THE SPEED PARAMETER

- Press the Up ▲ button to increase the Rpm or Down ▼ button to decrease the Rpm.
- Single press the Up button to increase the Rpm in the interval of 50 or single press the Down button to decrease the Rpm in the interval of 50.

- Speed indicator will be illuminated during this process.
- Once the desired Rpm is set press the SET button to get into the timer.

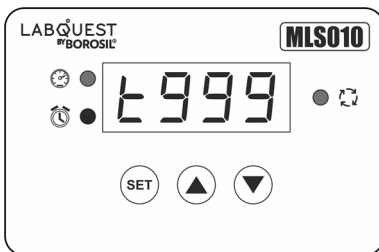

SETTING THE TIME PARAMETER

- Press the Up ▲ button to increase the time or Down ▼ button to decrease the time.
- Single press the Up button to increase the time in the interval of 1 min or single press the Down button to decrease the time in the interval of 1 min.

- Time indicator will be illuminated during this process.
- Once the desired time is set press the SET button to start the process.

FEATURES

RAMP SET

- User can set the ramp value from 0 to 2.
- When the ramp value is zero, the time taken to reach set value will be less.
- When the ramp value is maximum (2), the time taken to reach set value will be more (long).
- Default Ramp Value should be set to 0(recommended).

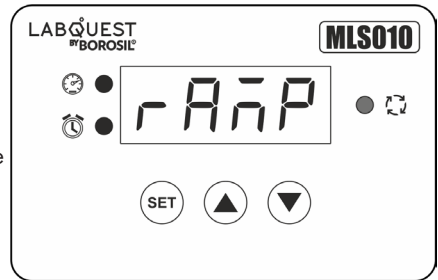

TIME SETTINGS

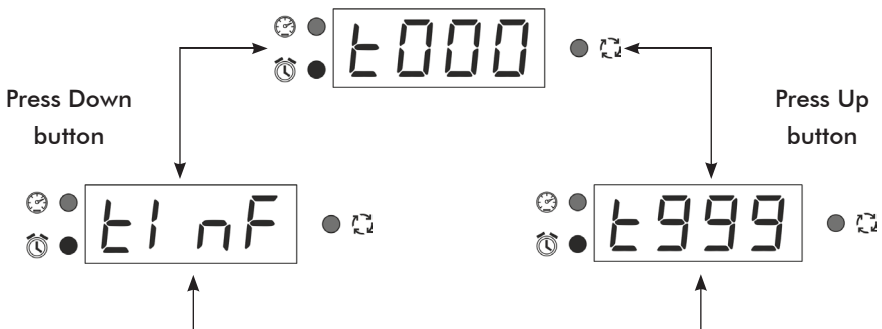

- If user sets infinite time then the timer window in the process will display elapsed time.
- The maximum elapsed time that will be displayed is 999 minutes.
- The process terminates itself after completion of 999 minutes.

SLIP DETECTION

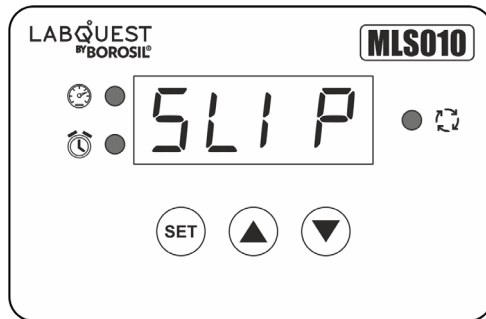

- Once the stir bar slips from its rotating position the unit will detect it as slip and “SLIP” will be shown on the display along with the buzzer sound.
- The speed will automatically slow down until the stirrer bar returns to its rotating position and again unit will try to reach the set Rpm.

TROUBLESHOOTING

The unit is not turning ON.

- Check the power supply in AC mains.
- Make sure adapter is connected to the plug properly.
- Check whether the main switch is **ON** or **OFF**.
- Check if the illuminated switch is **OFF**.
- Check if the unit is running and the switch is not illuminating, to replace the switch contact Borosil Service Center.



WARRANTY REGISTRATION

Please handover this registration form to the distributor from where you have purchased this product. The warranty is valid only when this warranty registration form is received by us within 30 days from the date of purchase.

Product: MLS010

Product Sr. No.: _____

Date of Invoice : _____

Invoice No.: _____

Customer name & address

Name : _____

Address: _____

Telephone: _____

E-mail: _____

Customer sign & seal

Dealer name & address

Name : _____

Address: _____

Telephone: _____

E-mail: _____

Dealer sign & seal

Alternatively, you may also email the filled warranty registration form to the lab.support@borosil.com

BOROSIL® Scientific

STATEMENT OF WARRANTY

Borosil confirms that this product has been manufactured in accordance with our technical specifications and quality requirements.

- Borosil warrants the product from manufacturing and workmanship defects for a period of 12 months from the date of invoice.
- Warranty is void, if equipment is not operated as prescribed in the operating manual supplied along with the unit.
- To be covered under warranty.
 - » Units have to be connected to standard 230V, 50Hz, 5A wall sockets with proper earthing for MLS010.
 - » Wear and tear of the equipment surface due to handling will not be covered under warranty.
 - » Warranty does not cover rust and physical damage to metal parts due to corrosive environment in the lab.

Terms:

- » In the event of malfunction due to defect, the buyer will have to follow the Borosil’s service process.
- » Certain units can not be serviced / rectified at the buyer’s place and the units may have to be brought to Borosil’s service center as advised by Borosil’s representatives.
- » In no event shall Borosil be liable for consequential or incidental damages.

INVOICE DATE	BUYER	AFFIX SERIAL NUMBER
INVOICE#		
Dealer name & address		Dealer sign & seal

BOROSIL SCIENTIFIC LIMITED

Corporate Office : 1101, Crescenzo G-Block, Opp. MCA Club, Bandra Kurla Complex, Bandra (E), Mumbai-400051, India.



: MANUFACTURED BY :

Borosil Scientific Limited

Plot No.7, Sr. No. 234, 235 & 245,
Indialand Global Industrial Park,
Hinjewadi Phase 1, Pune - 411057

Write to us on above address.

: MARKETED BY :

Borosil Scientific Limited

1101, G-Block, Parinee Crescenzo,
BKC, Bandra East, Mumbai - 51

Maharashtra, India

: CUSTOMER CARE CONTACT :

Phone : 1800 22 4551 | Email : lab.support@borosil.com

Website : www.borosilscientific.com