

LABQUEST
BY **BOROSIL®**

MANUAL FIBER ANALYZER

OPERATING MANUAL

MFB008

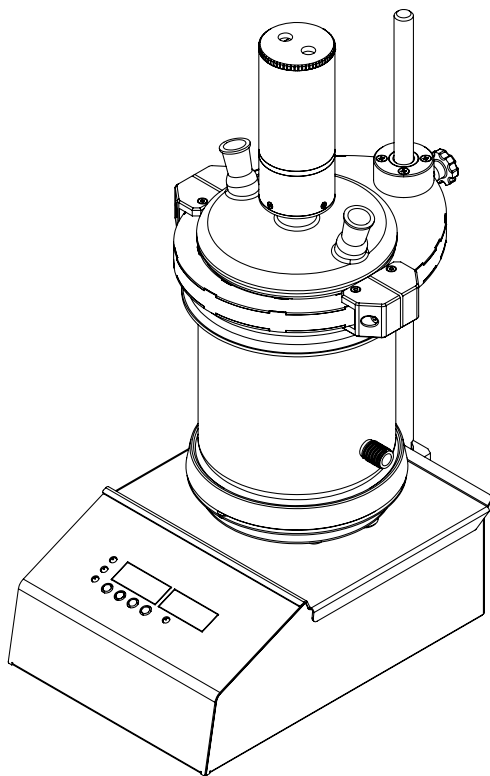

DEALER :

THANK YOU NOTE

We Borosil, one of India's most customer oriented brands truly appreciate your business and express our gratitude for the trust you have placed on us.

We hope your choice serves you well in your scientific endeavors and aspire to have the pleasure of doing business with you for years to come.

TABLE OF CONTENTS

Sr. No.	Particular	Page No.
1.	Specifications of the Product	6
2.	Packing List	7
3.	Safety and Warning	8
4.	Safety Precautions	9
5.	Unboxing of the Product	11
6.	Product Identification	12
7.	Tube Connection for the Unit	16
8.	Description of Buttons	17
9.	Features of MFB008	18
10.	Operations of MFB008	21
11.	Standard Operating Procedure	29
12.	Chemistry Troubleshooting	32
13.	Troubleshooting	35
14.	Warranty Registration	37
15.	Statement of Warranty	39
16.	Contact Information	40

SPECIFICATIONS

PARAMETERS	MFB008
Sap Code	BLFAMFB00800000000
Beaker Volume	3L
External Dimensions (L x W x D) mm	395 x 260 x 710mm
Mains Voltage	220V-240V
Current Consumption	3.6A
Power Consumptions	900W
Heater	Coil Heater
Body Material	Aluminum Powder Coated
Top Cover Material	SS304
Display	2 x 4 Digit Seven Segment Display
Temperature Sensor	K - Type Thermocouple
Dosing Funnel	Yes
Glassware Material	Borosilicate Glass
Min. Process Time (In min/8 sample)	120min
Ambient Temperature	15°C to 40°C
Measuring Range	0.5g to 2g
Reproducibility	<1%
Preset Program	Yes
Safe Temperature	Yes
Method	Fiber Bag Technology
Cooling Fan	Yes
Power Input	230 V, 50 Hz, 6 A
No. of Positions	8

PACKING LIST - BOX 1

Sr. No	Description	Quantity
1	MFB008 Control Unit	01 No.
2	Lid Support Shaft	01 No.
3	Tray Assembly	01 No.
4	Silicon Tube for condenser 8mm ID	01 No.
5	Silicon Tube for Drain 8mm ID	01 No.
6	Power Cable	01 No.
7	Lid Safety Stopper	01 No.
8	Stopper Knob	01 No.
9	Operating Manual	01 No.
10	Cable Tie 100mm	05 Nos.
11	Test Report	01 No.

PACKING LIST - BOX 2

Sr. No	Description	Quantity
1	Beaker	01 No.
2	Condenser	01 No.
3	Dosing Funnel	01 No.
4	Glass Spacer	10 Nos.
5	Lid Assembly	01 No.

SAFETY AND WARNING



Important operating and maintenance instructions

Read the accompanying text carefully.



Potential electrical hazards

Only qualified persons should perform procedures associated with this symbol.



Lifting hazard warning

- The MFB008 unit weighs more than 10Kg. Take adequate safety measures when moving this device.
- Equipment being maintained or serviced must be turned off and locked off to prevent possible injury.



CAUTION :

- Always use the proper protective equipments (clothing, gloves, goggles and face mask etc.)
- Always follow the good hygiene practices.
- Each individual is responsible for his or her own safety.
- Do not keep the unit on wet bench top.
- Do not wash the unit with water.
- Wipe the unit with dry cloth after usage.
- Ensure that no fluid is spilled on the top surface of the equipment.
- The unit should be plugged to standard 230V, 50Hz, 6A, 3 pin power socket.
- The unit should be plugged into the power socket, having proper earthing.



WARNING :

Inadequate earthing at the installation facility can lead to hazardous electrical shocks. The manufacturer is not liable for any injury or death resulting from electrical hazards due to faulty earthing in the lab.

SAFETY PRECAUTIONS

Hazardous Pressure

- Do NOT open the Vessel Lid during operation.
- The contents of the Vessel are hot and under pressure.
- Failure to observe this caution may result in scalding or burning.

Hot Surfaces

- Do NOT touch the Vessel surfaces during operation.
- Failure to observe this caution may result in burning.

Hazardous Voltages

- Check for Hazardous voltages present during operation.
- The Power Cord must be disconnected prior to removal of the bottom panel.
- Failure to observe this caution may result in electrical shock or electrocution.

Hazardous Materials

- Caution should be used when handling hot effluent that may be caustic or corrosive.
- If necessary, the solution can be collected in a container and neutralized before disposal.
- Follow safe laboratory practices according to your local regulations when installing and using this instrument and associated chemicals.



WARNING :

Attempts to override safety features or to use this instrument in a manner not specified by BOROSIL voids the warranty and may result in serious injury.

**IMPORTANT :**

- The Power Switch must be in the OFF position before plugging the instrument Power Cord into the power source.
- In the event of an instrument malfunction, the internal heater will be automatically turned off by one of the following safety devices :
 - 1) Electrical Fuses
- Do NOT open the Vessel Lid during or after an operation until both pressure and liquid are thoroughly exhausted.
- Connect and secure the Drain Hose along the path to the drain so it will not move when hot pressurized fluid is exhausted.

UNBOXING OF THE PRODUCT

UNPACKAGING INSTRUCTION

Remove from Box 1

- Control Unit
- Tray Assembly
- Support Shaft

FOR ACCESSORIES :

1. Remove from the pouch

- Silicon Tube For Condenser
8mm ID
- Silicon Tube for Drain 8mm
ID

- Power Cable 5 Amps
- Lid Safety Stopper
- Stopper Knob

2. Remove from box 2

- Beaker
- Condenser
- Dosing Funnel
- Glass Spacer
- Lid Assembly

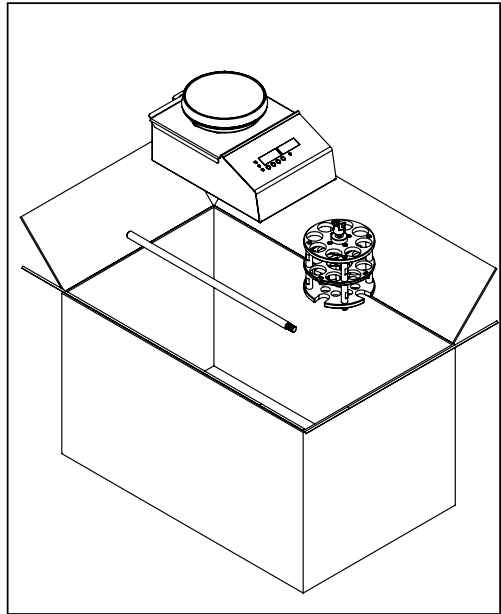

Fig. No. 11.1

PRODUCT IDENTIFICATION

- | | |
|-------------------|------------------------|
| A. CONDENSER | H. DOSING FUNNEL VALVE |
| B. GLASS LID | I. LID CLAMP |
| C. BEAKER | J. LID GASKET |
| D. HOT PLATE | K. DRAIN VALVE |
| E. CONTROL UNIT | L. 7 SEGMENT DISPLAY |
| F. DOSING FUNNEL | M. LEVELING SHOE |
| G. MOTOR ASSEMBLY | |

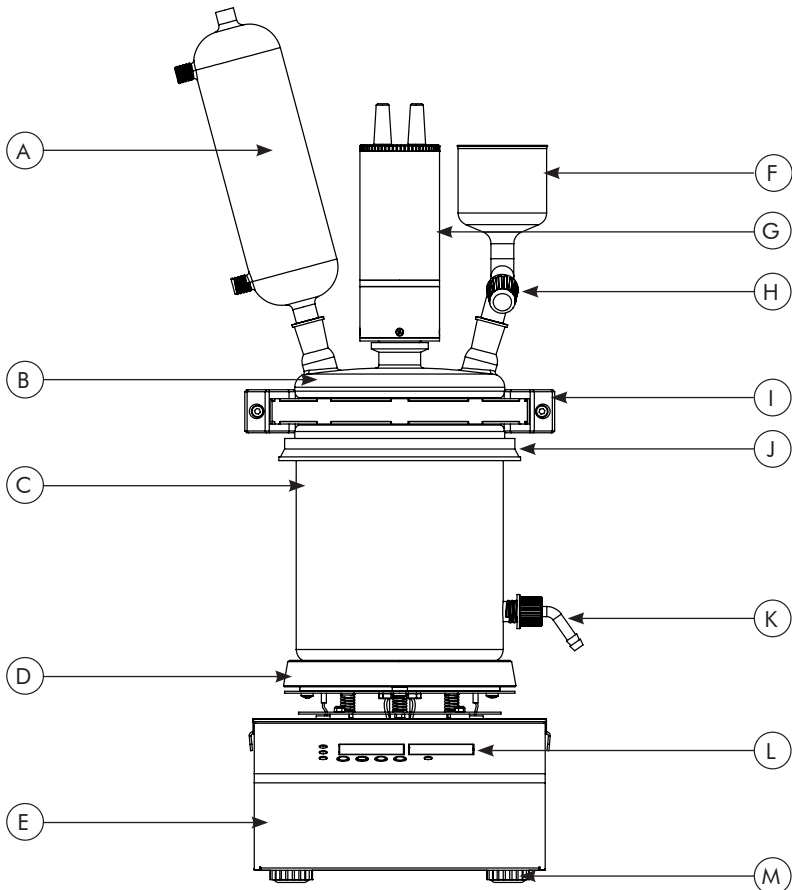

Fig. No. 12.1

PRODUCT IDENTIFICATION

- A. LID SUPPORT SHAFT
- B. SLIDER BUSH ASSEMBLY
- C. SLIDER KNOB
- D. SAFETY STOPPER
- E. SHAFT SUPPORT BLOCK
- F. POWER PLUG SOCKET with FUSE (6.3 Amp)
- G. POWER SWITCH
- H. MOTOR POWER CABLE SOCKET
- I. MOTOR FEEDBACK CABLE SOCKET
- J. PROGRAMME DUMP SOCKET
- K. COOLING FAN WINDS

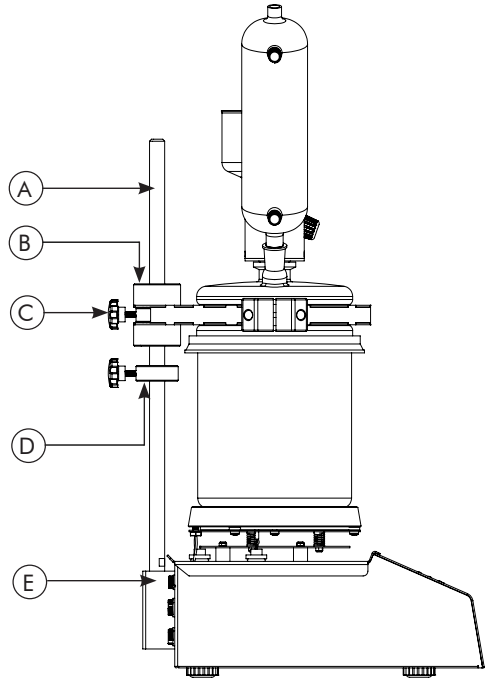

Fig. No. 13.1

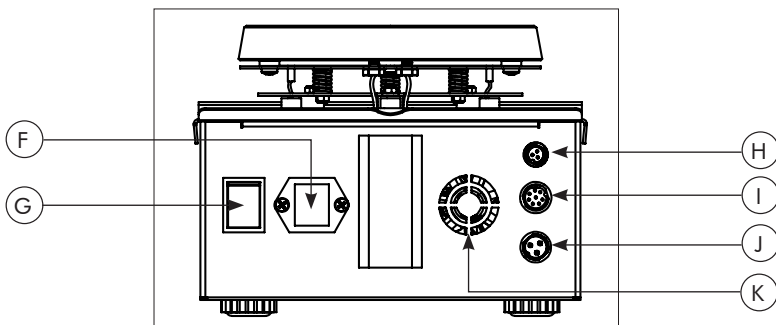

Fig. No. 13.2

PRODUCT IDENTIFICATION

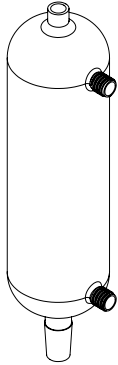

Fig. 14.1

CONDENSER
BLGAMFB0081000003

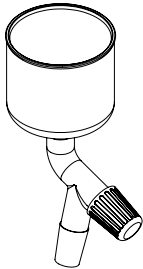

Fig. 14.2

DOSING FUNNEL
BLGAMFB0081000002

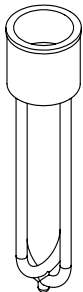

Fig. 14.3

GLASS SPACER
BLGAMFB0081000004

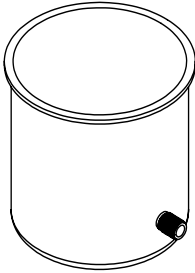

Fig. 15.1

BEAKER
BLGAMFB0081000001

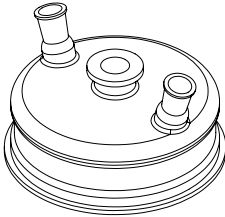

Fig. 15.2

GLASS LID
BLGAMFB0081200001

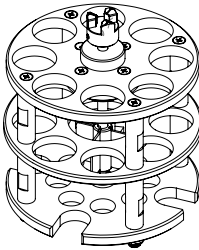

Fig. 15.3

TRAY ASSEMBLY
BLMAMFB00811000000



Fig. 15.4

FIBER FILTER BAG
BLAAMFB008CRC00000

TUBE CONNECTION FOR THE UNIT

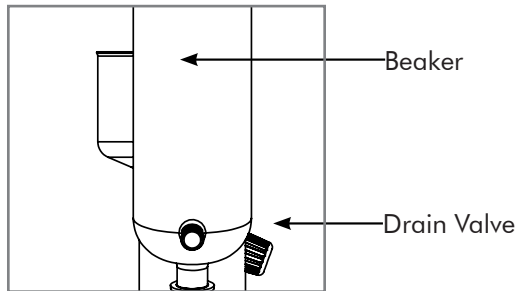

Fig. No. 16.1

1. Remove the silicon tube from the accessories pouch provided with the unit box no.1.
2. Connect the silicon tube to the drain valve (Ref. Fig. No. 16.1).
3. Before starting the unit, fix the stop valve in the silicon tube.
4. Connect the chiller to the condenser through silicon tube provided with the unit.

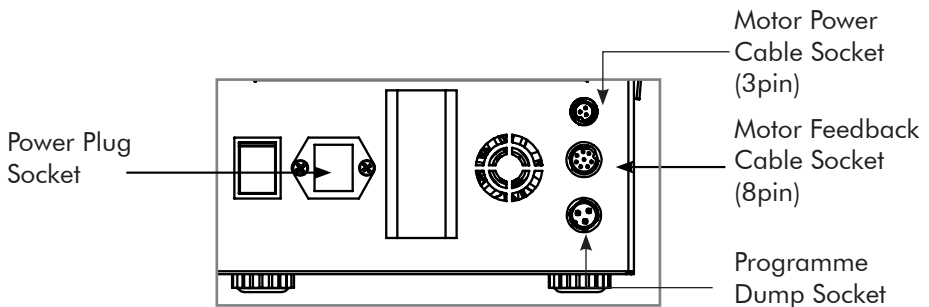
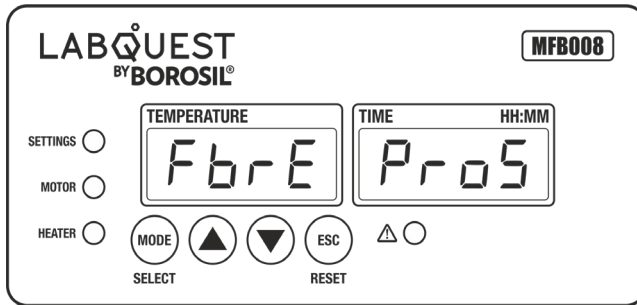

Fig. No. 16.2

1. Remove the power cable from the accessories pouch provided with the unit box no.1.
2. Connect the motor power cable (3pin) & feedback cable (8pin) from the lid motor assembly to the specified socket as shown in the fig no.16.2.

Note : Do not insert any cable into the "Programme Dump Socket", it is for service use only.

DESCRIPTION OF BUTTONS



1. **MODE/SELECT** (MODE) :

- Single press to go next stage of the process.
- Long press is used to enter in to setting menu.

2. **UP** (▲) :

- To increase the set point values and to scroll up the setting menu.

3. **DOWN** (▼) :

- To decrease the set point values and to scroll down the setting menu.

4. **RESET** (ESC) :

- Single press used to go back to previous stage (back function) and to exit from settings mode.
- Long press used to exit from the settings menu and to stop the process.

FEATURES OF MFB008

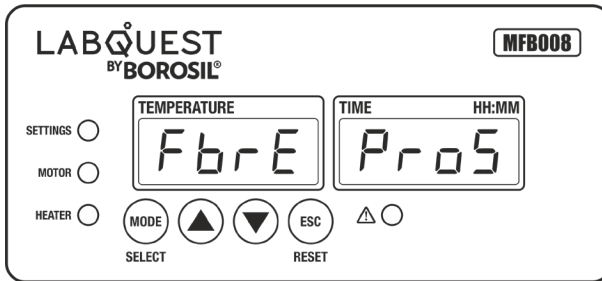

- Long press MODE button to enter SETTINGS menu while "FbrE" is displayed on first display and "Pr05" on second display.
- In settings, Left side display will show Parameter while right side display shows selected previous stored values while editing.
- To change/edit value of Parameter single press MODE button then second display will start blinking. To change current values press UP or DOWN button.
- For save that change values, single press MODE button. Second display will stop blinking and user will see the selected values of parameter on second display.
- If user does not want to change the values of parameter and wants the previous selected values of parameter then single press ESC/ RESET button and parameter will stop blinking and user will see the previous selected parameter values on second display.

FEATURES OF MFB008

1. Heating Time

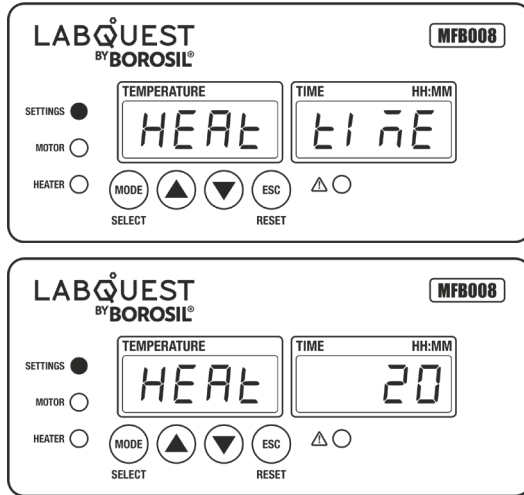

- User can set heating time as per environmental conditions for the process.
- The set 20mins is recommended for the ideal room temperature.

2. SAFE Temperature



- In this feature, user can lock the maximum heating temperature to prevent any damage to the instrument due to overheating.

3. Stirrer on Time

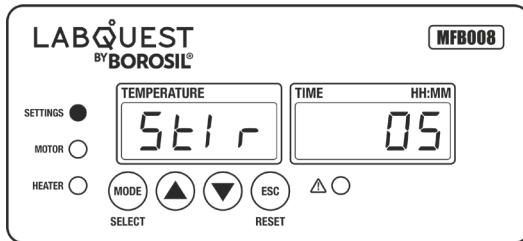
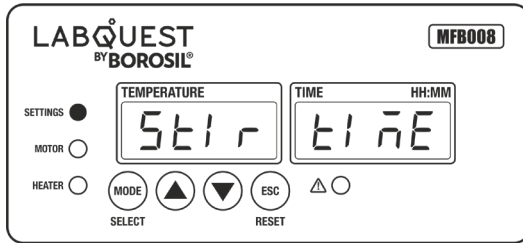

- User can set Stir on time here as per their requirement for the washing cycle.

4. Boil Time

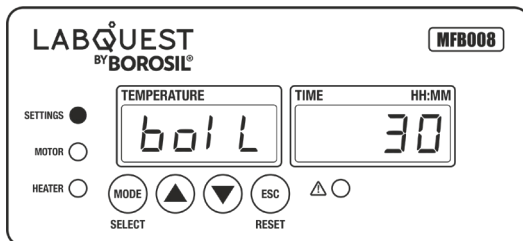
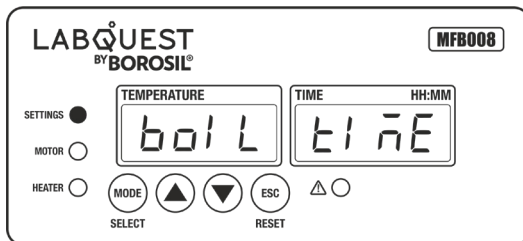

- User can set solution boil on time here as per their requirement for the process.

OPERATIONS OF MFB008

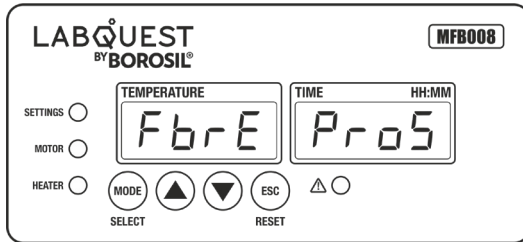

- By default, power ON condition display will show the home page “FbrE” and “Pro5”.
- All LED will be OFF.
- Single press MODE key to choose the process.
- After single press of MODE key following window will pop up.
- Once the following window pops up, the user can go scroll through the other process using pressing INC /DNC key.

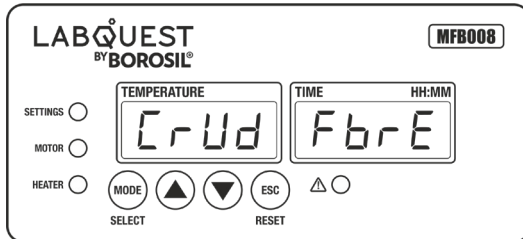

Crude Fiber

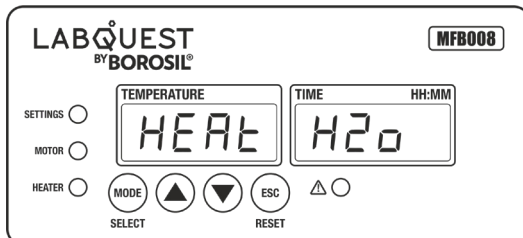

Heat Water

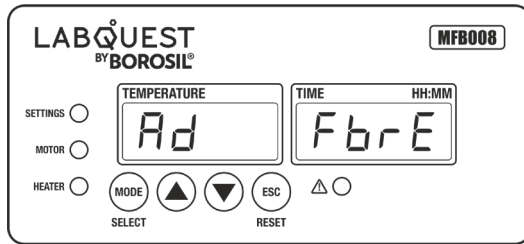

Acid Detergent Fiber

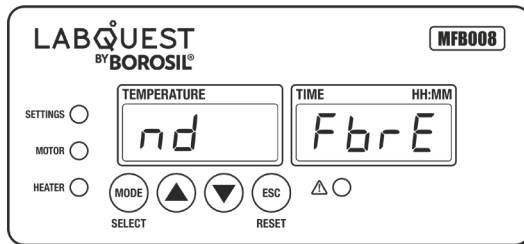

Neutral Detergent Fiber

- Select a process among crude fiber, heat water, acid detergent fiber and neutral detergent fiber using single press of MODE key.

CRUDE FIBER PROCESS

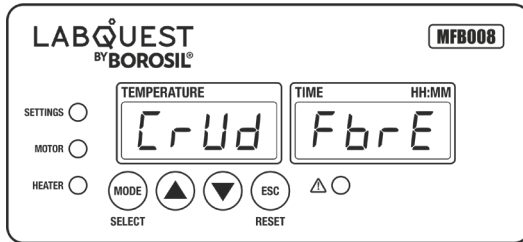

- After single press of MODE key, the following window will pop up.

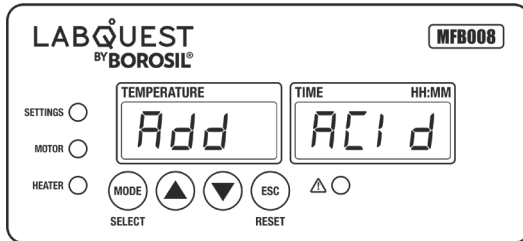

- The display will indicate to add acid into the beaker.
- Open the dosing funnel and add acid upto the fill level marked in the beaker.
- Single press MODE key to start heating of acid.
- Heater LED will turn ON to indicate that the heater is ON.

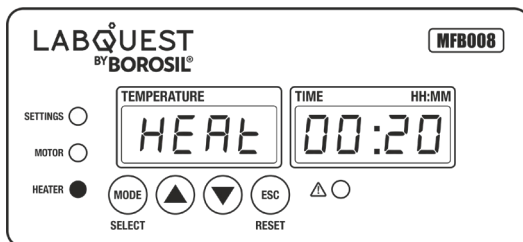

- The acid will be heated upto boiling for the set time.
- After the timer completes, following window will flash 3 times along with auditory indication which shows stirrer is ON for further process.

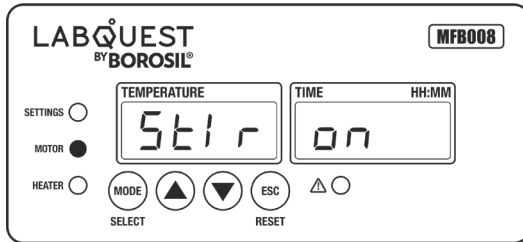

- This window will flash 3 times indicating stirring process has been initiated.

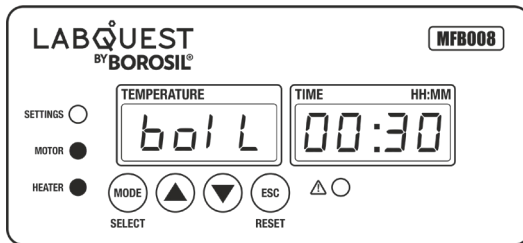

- The stirrer will turn ON for acid digestion for the set time with the following window showing.

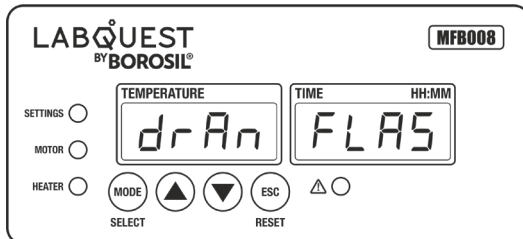

- After the elapsed time, the display will indicate to drain the beaker as acid digestion is complete.
- Open the drain valve to remove all residue of the acid digestion process.

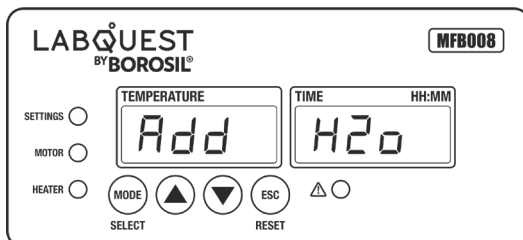

- After all the residue is drained, close the drain valve and add distilled water to wash the residue acid in the beaker, bags and the sample.
- Single press MODE key for next step.

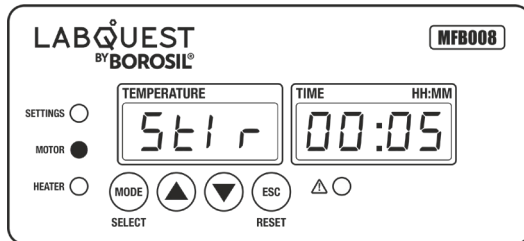

- Single press MODE key to start the washing process. Perform washing process twice to ensure complete removal of all acid residue in the system.

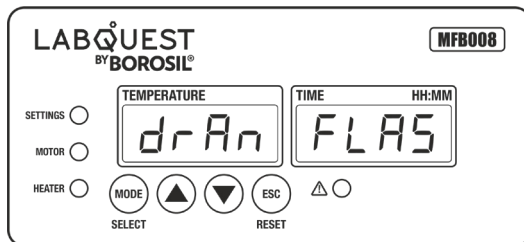

- Drain the residue water after the washing process.

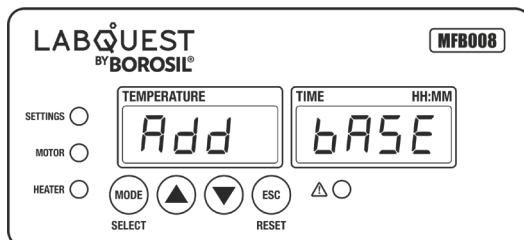

- The display will indicate to add base into the beaker.
- Open the dosing funnel and base upto the fill level marked in the beaker.
- Single press MODE key to start heating of base.
- Heater LED will turn ON to indicate that the heater is ON.

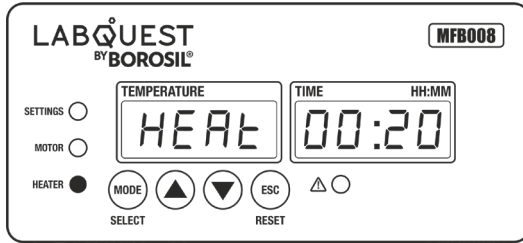

- The base will be heated upto boiling for the set time.
- After the timer completes, following window will flash 3 times along with auditory indication which shows stirrer is ON for further process.

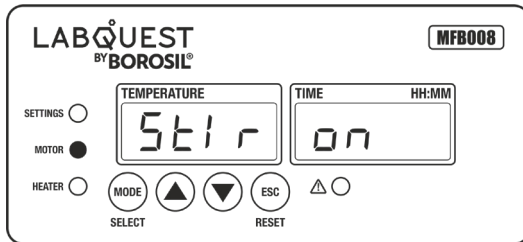

- This window will flash 3 times indicating stirring process has been initiated.

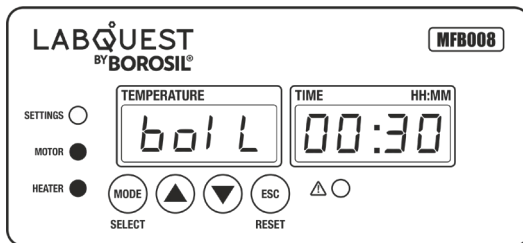

- The stirrer will turn ON for base digestion for the set time with the following window showing.

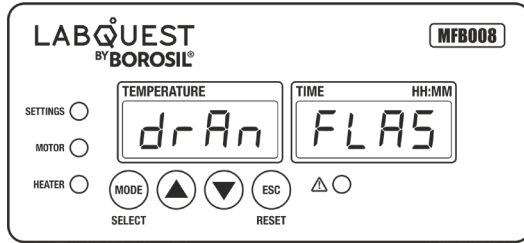

- After the elapsed time, the display will indicate to drain the beaker as base digestion is complete.
- Open the drain valve to remove all residue of the base digestion process.

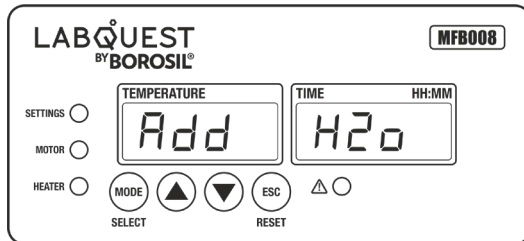

- After all the residue is drained, close the drain valve and add distilled water to wash the residue acid in the beaker, bags and the sample.
- Single press MODE key for next step.

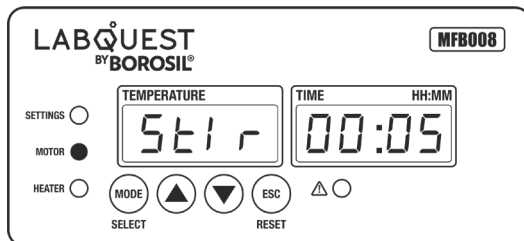

- Single press MODE key to start the washing process. Perform washing process twice to ensure complete removal of all acid residue in the system.

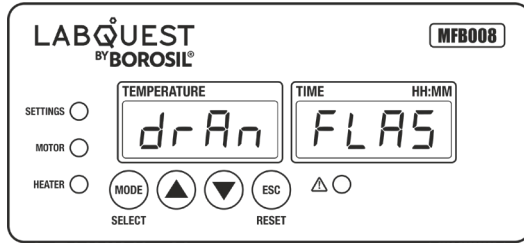

- After the elapsed time, the display will indicate to drain the beaker as base digestion is complete.
- Open the drain valve to remove all residue of the base digestion process.

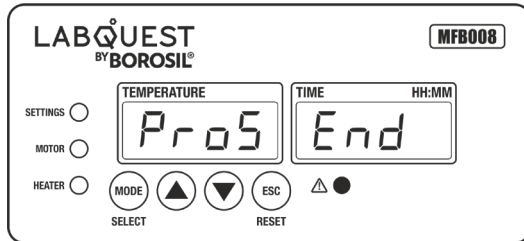

- This window will show Process is completed.
- Alarm LED will flash 3 time with audio indication.
- After Process completion, system will go to the "FbrE" and "PrS".

STANDARD OPERATING PROCEDURE

Purpose	To Determine Crude fiber (%) present in sample Also to check and evaluate Statistical Parameter (Accuracy, Repeatability, Std-deviation, Precision, Variance with classical method)
Scope	This Standard Operating Procedure (SOP) applies to people using crude fiber analyser machine by AOAC 962.09
Principle	Crude fiber analysis (Fiber bag method). The method consisted of treatment of samples with acid and alkali, resulting in a residue (crude fiber).

APPARATUS

1. Analytical Balance—capable of weighing down to 0.1 mg.
2. Oven—capable of maintaining a temperature of $102 \pm 2^\circ\text{C}$.
3. Electric muffle furnace—with rheostat control and pyrometer that will maintain a temperature of $600 \pm 15^\circ\text{C}$.
4. Borosil Digestion instrument—capable of performing the digestion at $100 \pm 0.5^\circ\text{C}$.
5. Filter bags—constructed from chemically inert and heat resistant filter media, capable of being heat sealed closed and able to retain 20 micron particles while permitting rapid solution penetration.

REAGENTS

1. Sulfuric acid solution— $0.255 \pm 0.005\text{N}$, 1.25 g $\text{H}_2\text{SO}_4/100$ mL.
Concentration must be checked by titration.
2. Sodium hydroxide solution— $0.313 \pm 0.005\text{N}$, 1.25 g $\text{NaOH}/100$ mL.
Concentration must be checked by titration.

PREPARATION OF SAMPLE

1. Grind samples and sieve it through a 2 mm screen or 1 mm screen.
2. Samples ground finer may show particle loss from the filter bags and result in low values.

PROCEDURE

1. Use a solvent or acid resistant marker (or ball pen) to number the filter bags. Weigh filter bag and zero balance.

(Note: Do not pre-dry filter bags; any moisture will be accounted for by the blank bag correction)

2. Weigh 1.0 - 2 g of prepared sample directly in the filter bag. Avoid adding samples more than half the level of the bag. Weigh the bags and the sample and record the weight.
3. Weigh minimum one and maximum two blank bags and include it in the run to determine blank bag correction.
4. Extract fat from samples by placing all bags into a 250 mL container. Add enough petroleum ether to cover the sample and soak for 10 min. Pour off solvent and allow bags to air-dry. Spread the sample uniformly inside the filter bag by shaking and flicking the bag to eliminate clumping.

(Note - Fat extraction/removal is to be done, only if fat content is more than 5%).

5. Insert the spacers into the bag containing the sample.
6. Place all the bags into the tray and insert the tray into the beaker.
7. Then place the vessel on the heating surface of the machine.
8. Drop the lid and make sure the stirrer is coupled. Turn ON the unit and select the required process.
9. Set the process and add approximately 1500 ml of acid (0.255N H₂SO₄) into the vessel through the dosing funnel provided on the lid.
10. Perform digestion for a total of 30 min excluding the time of heating the solution.
11. Once the acid digestion process is completed, drain the acid through the drain valve provided in the beaker.
12. Add 1500 ml of hot water (50-85°C) through a dosing funnel and agitate for 5 min to wash the acid from the previous process. Repeat the washing process as per programme.
13. Now pour 1500mL of ambient temperature base (0.313N NaOH) solution to the beaker with the help of a dosing funnel.
14. Perform digestion for a total of 30 min excluding the time of heating.

15. Open the drain valve after the process is finished.
16. Add 1500 mL of (50-85°C) water through the funnel and agitate for 5 min to wash the base from the previous process. Repeat the washing process as per programme.
17. When the two rinsing processes are complete, remove the beaker from the machine, then gently remove the bags from the spacer by adding water so that no samples are stuck to the glass spacer. Gently press out excess water from bags with the adequate water. Place bags in a 250 mL beaker and add enough acetone to cover bags and soak for 3-5 min.
18. Remove bags from acetone and place on a wire screen to air-dry. Completely dry the bags in the oven at $102 \pm 2^\circ\text{C}$ for 2 hours.

Note: Do not place bags in the oven until acetone has completely evaporated.

19. Remove bags from the oven, place directly into a desiccator
20. Along with the bags weigh the crucible too and record the dry weights.
21. Ash the entire bag/sample in a pre-weighed crucible for 2 hrs at $600 \pm 15^\circ\text{C}$, cool in a desiccator and weigh to calculate loss of weight of organic matter.

CALCULATION

$$\% \text{ Crude Fiber} = (((M3-M1-M4)-(B3-B1-B4))/M2) \times 100$$

Where:

M1 - Weight of empty bag

M2 - Weight of sample

M3 - Weight of dried bags with sample after digestion + Weight of crucible

M4 - Weight of ash with crucible

B1 - Average weight of blank bags

B3 - Average weight of dried blank bags after digestion + weight of crucible.

B4 - Average weight of blank bags ash with crucible.

PRECAUTIONS TO BE FOLLOWED

1. Chiller temperature should be kept at 20°C .
2. Ideally the sample should be moisture free. If not, calculation should be on the moisture and moisture free basis.
3. Make sure the sample is homogeneous and grounded properly.
4. Use silicone antifoam (5mL) during the addition of acid and alkali.

CHEMISTRY TROUBLESHOOTING

Reasons for failure or incorrect results are given and correlated to the corrective measures

Result	Possible Cause	Corrections
Result Variation	Undried, non homogenized sample	Dry the sample and homogenise properly. (if possible grind it)
	Error in calculation	<p>Check formula</p> $\% \text{ Crude Fiber} = \frac{((M3-M1-M4)-(B3-B1-B4)) \times 100}{M2}$ <p>Where: M1 - Weight of empty bag M2 - Weight of sample M3 - Weight of dried bags with sample after digestion with Weight of crucible M4 - Weight of ash with crucible B1 - Average weight of blank bags B3 - Average weight of dried blank bags after digestion with weight of crucible. B4 - Average weight of blank bags ash with crucible.</p>
	Leakages : There may be leakage in GLs connectors and glassparts	Check the glass parts and GL and fit it tightly / Seal it.
	Precaution to be followed	<ul style="list-style-type: none"> • Chiller temperature should be kept at 20°C. • Ideally the sample should be moisture free. If not, calculation should be on the moisture and moisture free basis. • Make sure the sample is homogeneous and grounded properly. • Use silicone antifoam (5mL) during the addition of acid and alkali.

Result	Possible Cause	Corrections
	Error in calculation	Same as above.
Poor reproducibility	Weighing	<ul style="list-style-type: none"> • Take accurate weight of both sample and fiber bag upto 4 decimals and tare the weight of butter paper. • Calibrate the balance.
Poor Accuracy	Results variation	<ul style="list-style-type: none"> • If the sample contains <5% fat, then sample can be defatted. • If the sample contains >5% fat, then sample should be defatted.
	Non homogeneous sample	Homogenize the sample.
	Particle size	Particle size of the sample should be 20 mesh.
	Sample weight too large	<ul style="list-style-type: none"> • Revise sample quantity. • Recommended amount is 1-3gm only.

TROUBLESHOOTING

S.NO.	PROBLEM	SOLUTION
1.	The unit is not turning ON.	<ul style="list-style-type: none"> • Check the power supply in mains. • Make sure power cable is inserted to the socket properly. • Check whether the main switch is ON or OFF. • If illuminated switch is not ON, please check the fuse.
2.	If the fuse is blown.	<ul style="list-style-type: none"> • Switch OFF the unit and remove power cable from AC mains. • On the right side of the equipment a fuse holder is present, remove the holder. • Check whether the fuse is damaged, if yes, please replace it with a spare fuse provided in the box.
3.	If the heater is not getting ON.	<ul style="list-style-type: none"> • Check the power supply in mains. • Check whether the switch is ON. • If the problem persists, please contact Borosil Service Center.



WARRANTY REGISTRATION

Please handover this registration form to the distributor from where you have purchased this product.

The warranty is valid only when this warranty registration form is received by us within 30 days from the date of purchase.

Product : MFB008

Product Sr. No.: _____

Date of Invoice : _____

Invoice No.: _____

Customer name & address

Name : _____

Address: _____

Telephone: _____

E-mail: _____

Customer sign & seal

Dealer name & address

Name : _____

Address: _____

Telephone: _____

E-mail: _____

Dealer sign & seal

BOROSIL® Scientific

STATEMENT OF WARRANTY

Borosil confirms that this product has been manufactured in accordance with our technical specifications and quality requirements.

- Borosil warrants the product from manufacturing and workmanship defects for a period of 12 months from the date of invoice.
- Warranty is void, if equipment and apparatus is not operated as prescribed in the operating manual supplied along with the unit.
- To be covered under warranty.
 - Units have to be connected to standard 230V, 50Hz, 6A wall sockets with proper earthing.
 - Corrosion damage due to spillage of chemical will not be covered under warranty.
 - Glass being Fragile in Nature - **NO WARRANTY** for Glass Parts is applicable.
 - Warranty does not cover rust and physical damage to metal parts due to corrosive environment in the lab.

Terms:

- In the event of malfunction due to defect, the buyer will have to follow the Borosil’s service process.
- Certain units can not be serviced/rectified at the buyer’s place and the units may have to be brought to Borosil’s service center as advised by Borosil’s representatives.
- In no event shall Borosil be liable for consequential or incidental damages.

INVOICE DATE	BUYER	AFFIX SERIAL NUMBER
INVOICE#		
Dealer name & address		Dealer sign & seal

BOROSIL SCIENTIFIC LIMITED

Corporate Office : 1101, Crescenzo G-Block, Opp. MCA Club, Bandra Kurla Complex, Bandra (E), Mumbai-400051, India



: MANUFACTURED BY :

Borosil Scientific Limited

Plot No. 7, Sr. No. 234, 235 & 245,
Indialand Global Industrial Park,
Hinjewadi Phase 1, Pune - 411057.

Write to us on above address.

: MARKETED BY :

Borosil Scientific Limited

1101, G-Block, Parinee Crescenzo,
BKC, Bandra East, Mumbai - 51

Maharashtra, India.

: CUSTOMER CARE CONTACT :

Phone : 1800 22 4551 | Email : lab.support@borosil.com

Website : www.borosilscientific.com